



\*1411Z\_1  
411\*

edilians.com

NOS SOLUTIONS



# TP

## NOTICE DE MONTAGE

C-TP- 15/11/2021



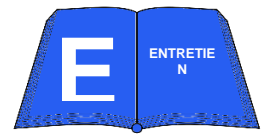
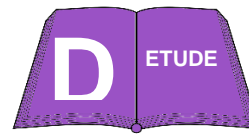
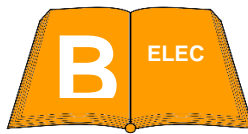

Tutoriel vidéo : <https://youtu.be/n1d6cDNxBVo>



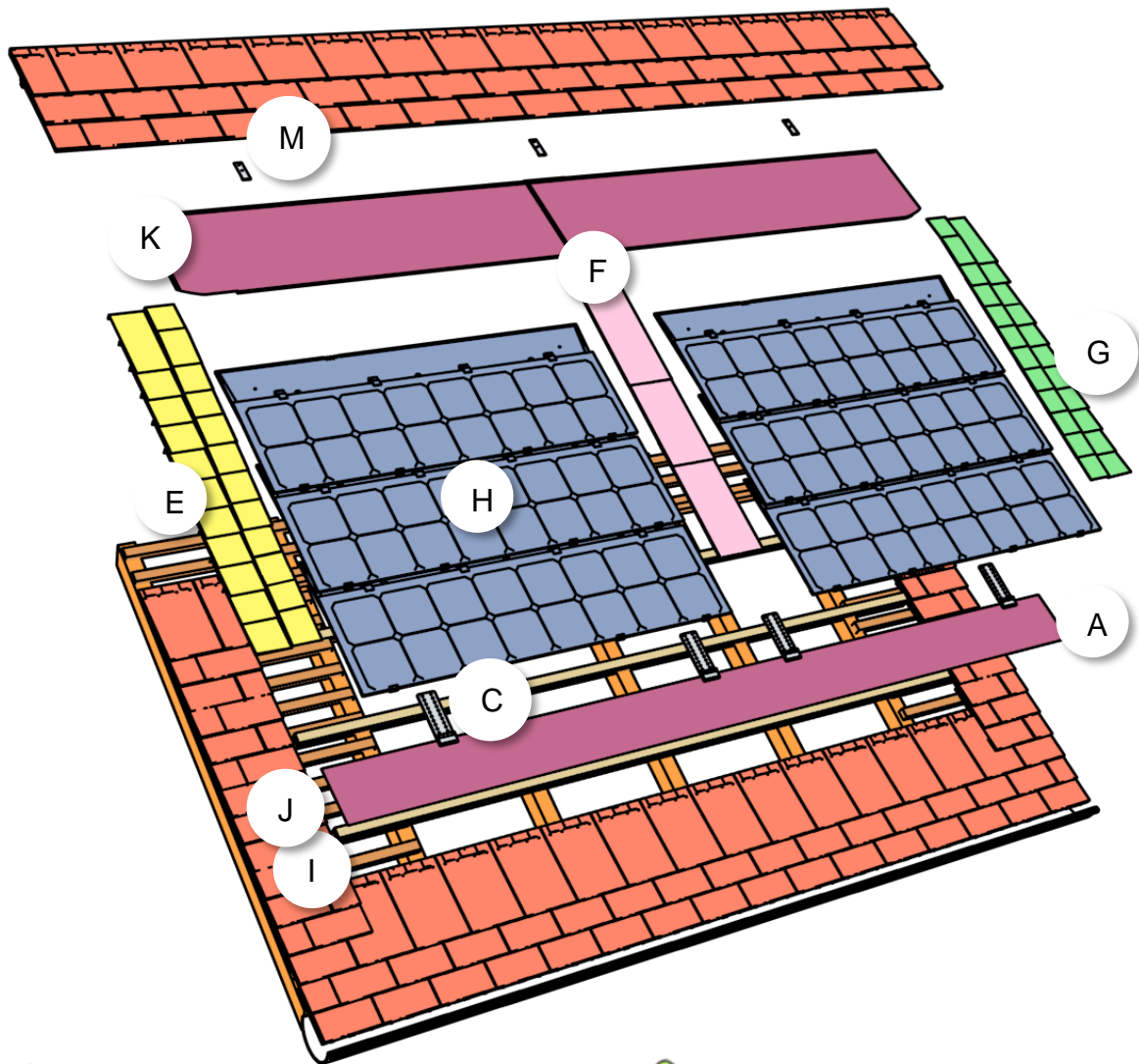

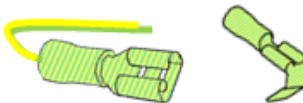
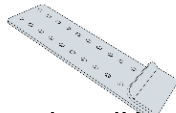
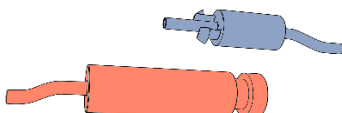
# NOMENCLATURE

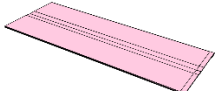
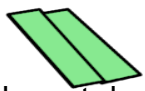
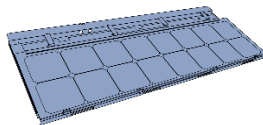
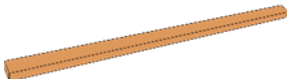
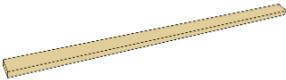

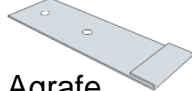
- |  |   |  |
|--|---|--|
| <p><b>A</b> <br/>Bavette bas de champ</p> | <p><b>B</b> <br/>Câble de terre / Double cosse</p> | <p><b>C</b> <br/>Crochet d'égout</p>                          |
| <p><b>D</b> <br/>Connecteurs DC</p>       | <p><b>E</b> <br/>Noquet gauche</p>                 | <p><b>F</b> <br/>Couloir central</p>                          |
| <p><b>G</b> <br/>Noquet droit</p>         | <p><b>H</b> <br/>Tuile photovoltaïque</p>          | <p><b>I</b> <br/>Liteau identique au liteau de couverture</p> |
| <p><b>J</b> <br/>Liteau 20x40</p>         | <p><b>K</b> <br/>Bavette rigide</p>                | <p><b>M</b> <br/>Agrafe</p>                                   |

# 1. MISE EN PLACE DES LITEAUX PHOTOVOLTAÏQUE

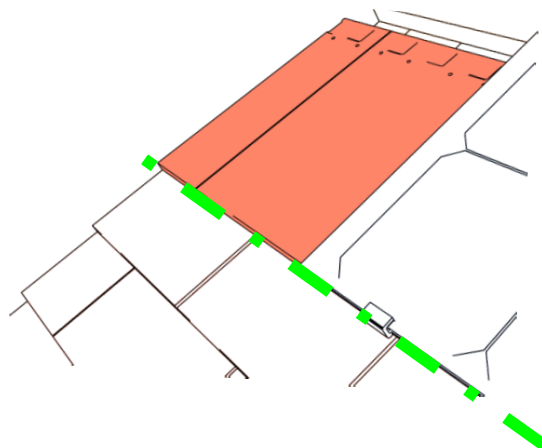
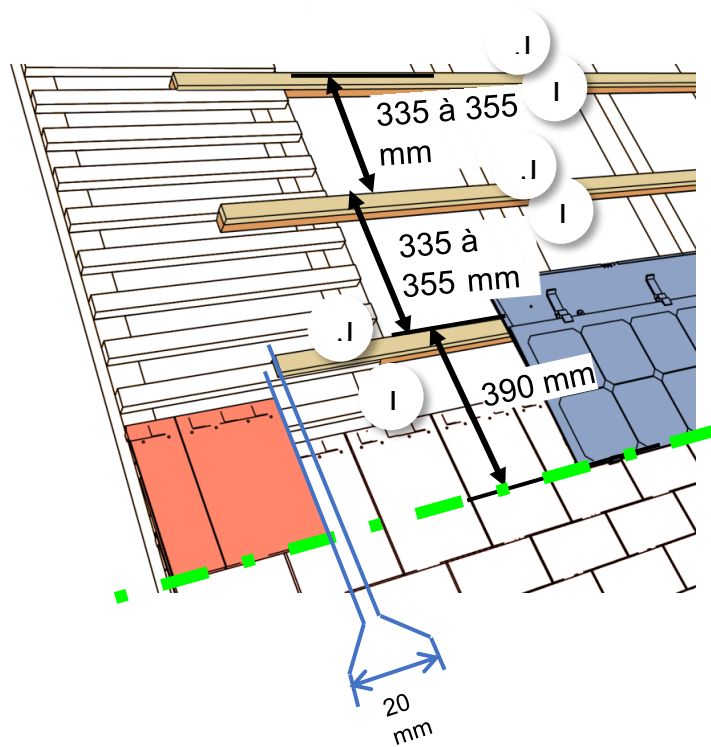
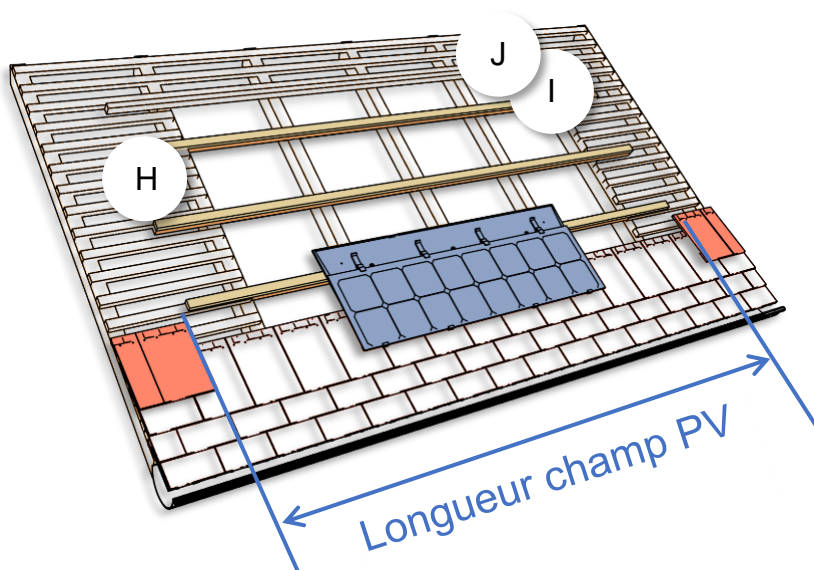

## 2. FIXATION BAVETTE BASSE ET DES CROCHETS D'EGOUT

### Cas 1 : Pose à l'égout

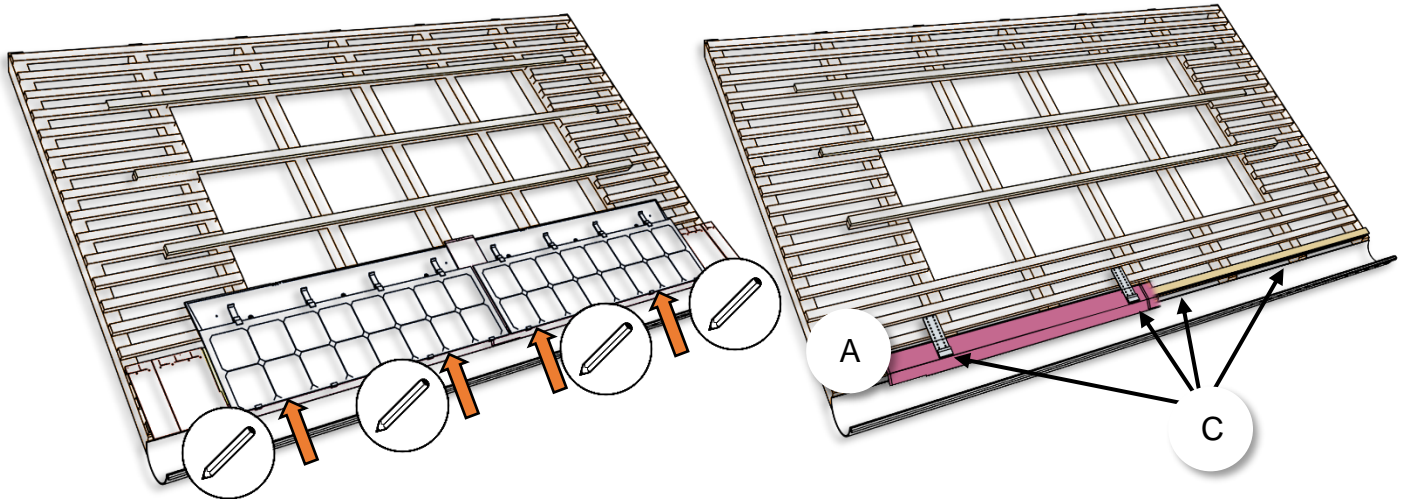

Présenter la ligne du bas du champ photovoltaïque sur la toiture, positionner les produits de couverture à chaque extrémité puis, repérer la position des crochets d'égout en face des encoches à droite et à gauche du châssis. Larmier aligné aux produits de couverture.

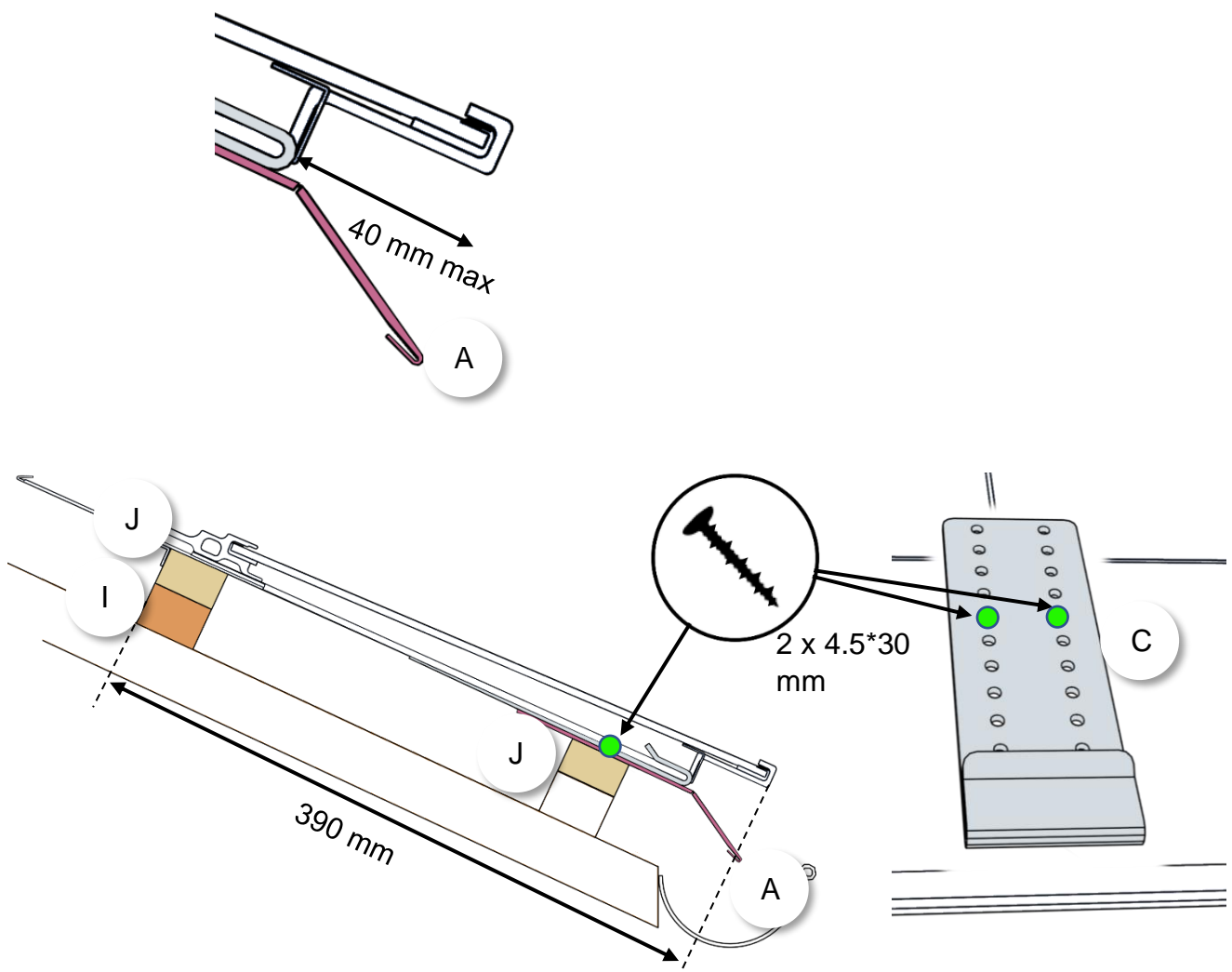



## Cas 2 : Pose en plain carré

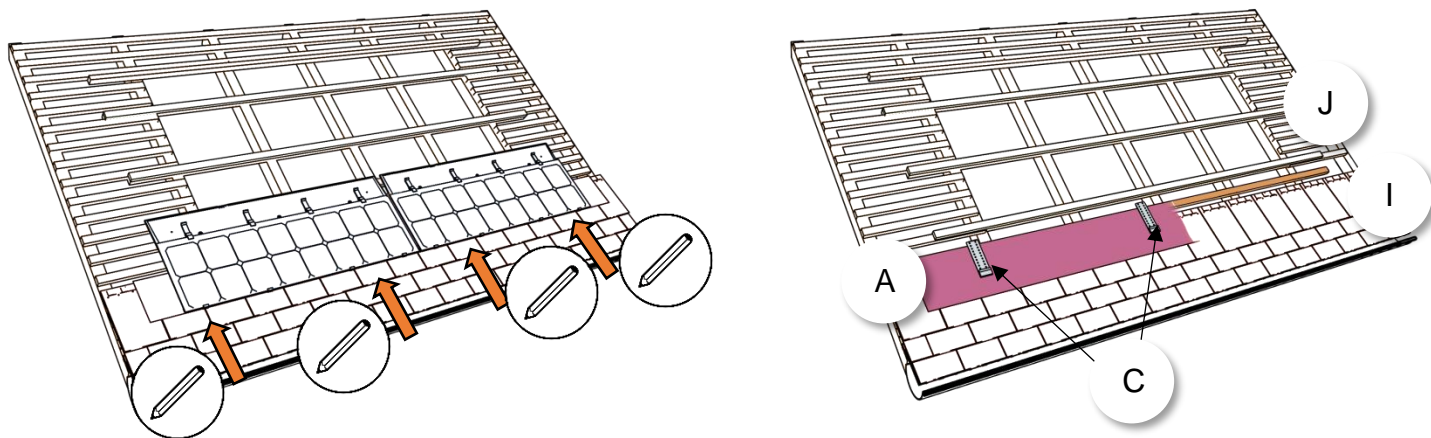

Ecartement maxi entre 2 colonnes : 50 mm de laminé à laminé

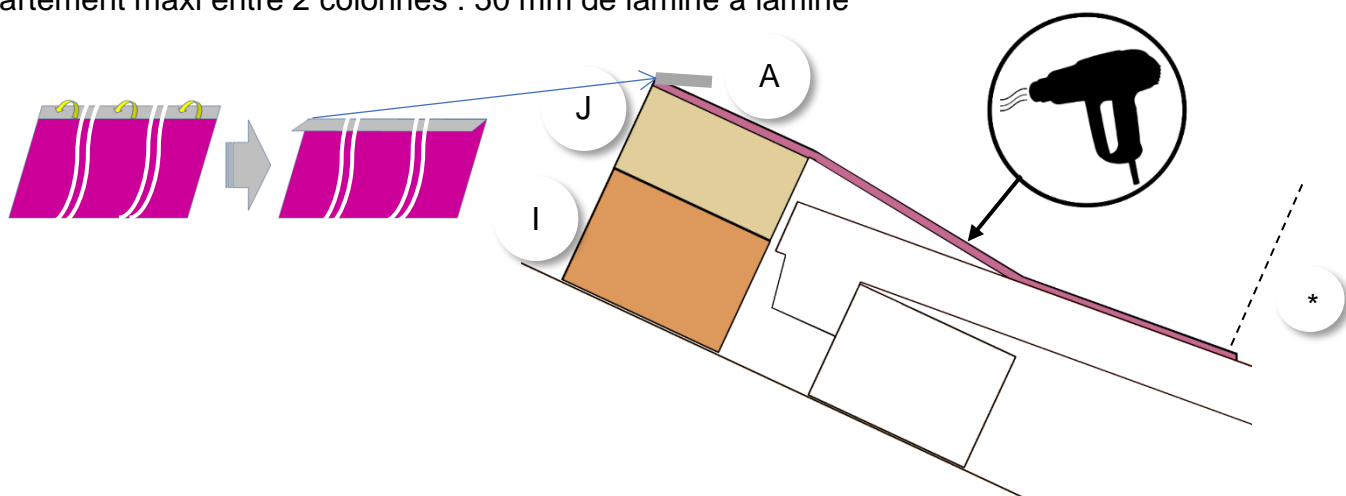

Présenter la ligne du bas du champ photovoltaïque sur la toiture, positionner les produits de couverture à chaque extrémité puis, repérer la position des crochets d'égout en face des encoches à droite et à gauche du châssis. \*Larmier aligné aux produits de couverture

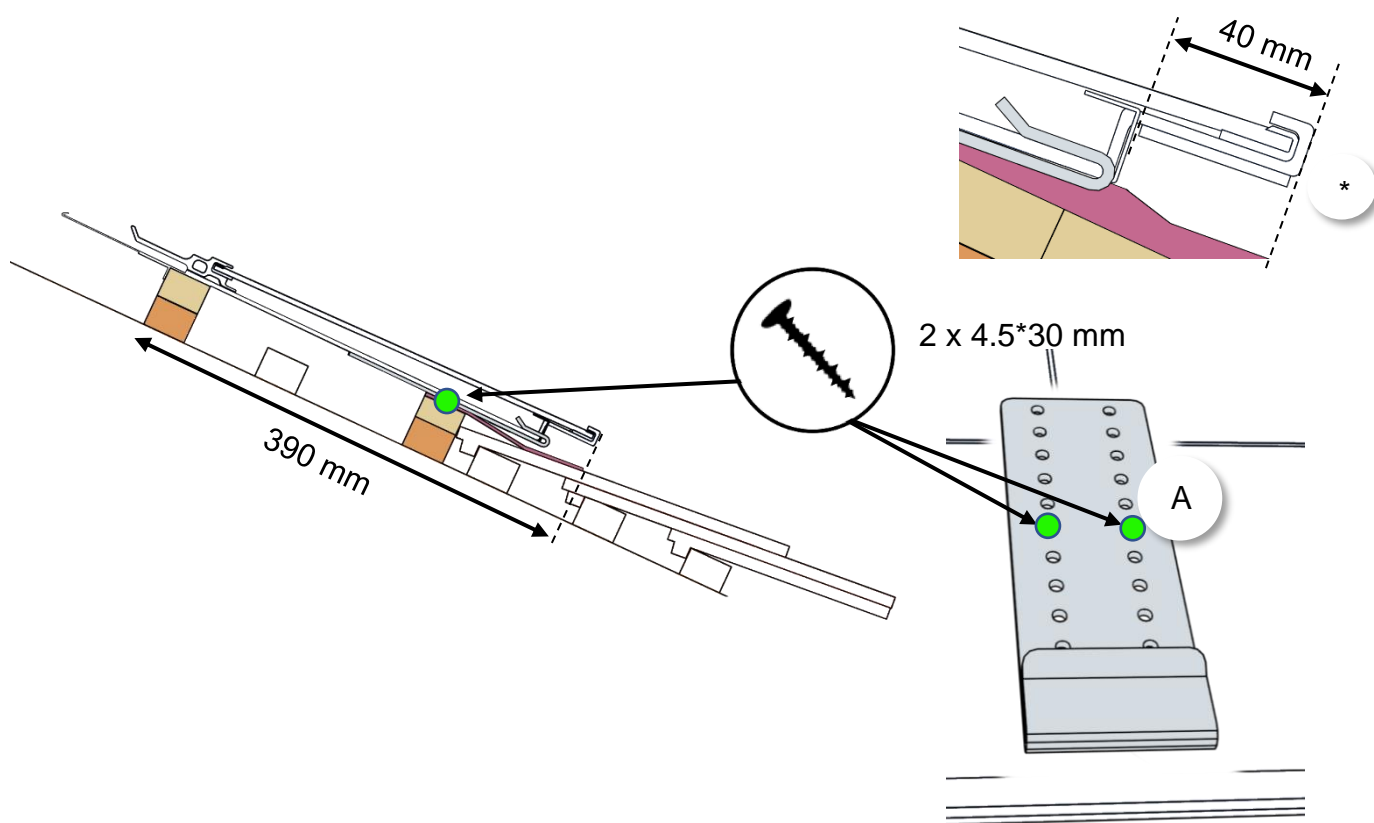

### 3. POSE DE LA PREMIERE LIGNE TUILE PHOTOVOLTAÏQUE

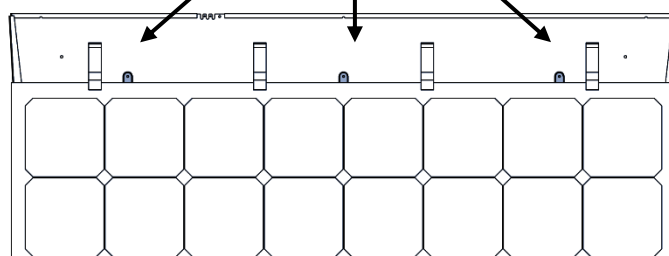
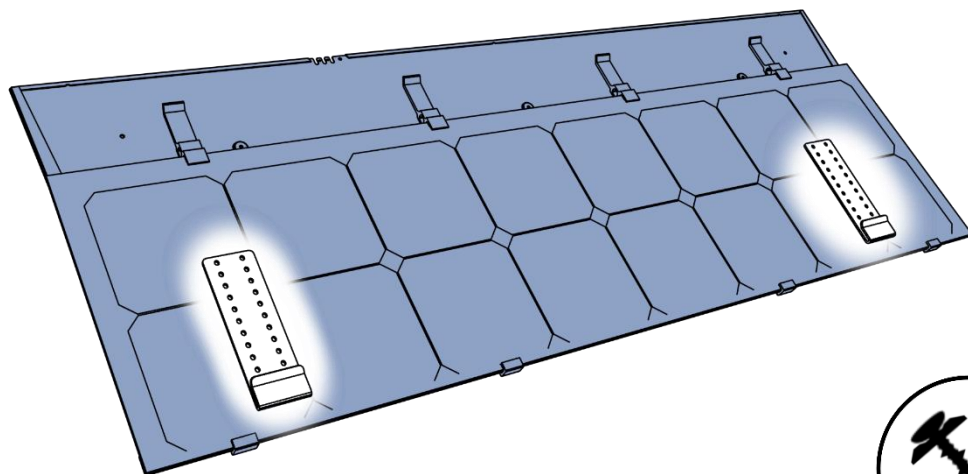
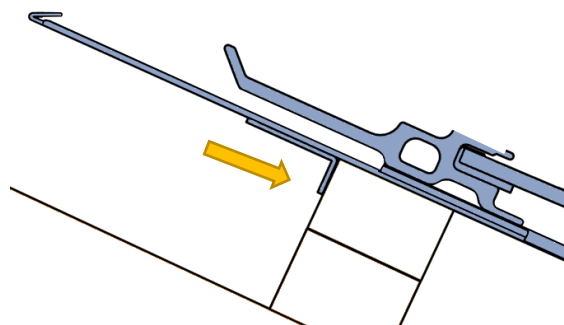
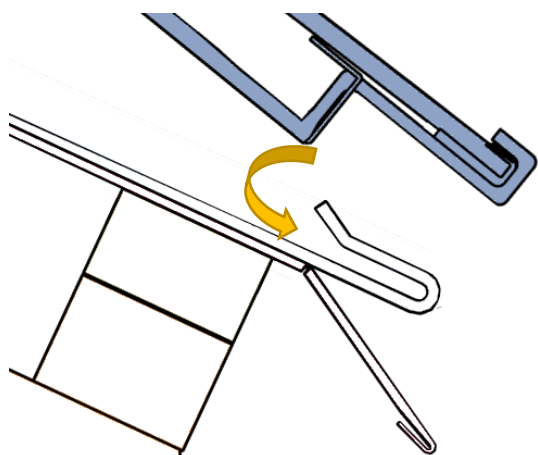
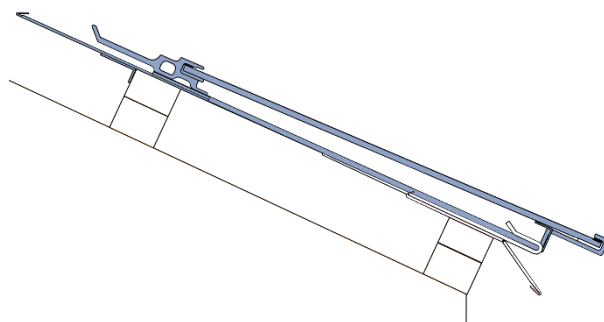
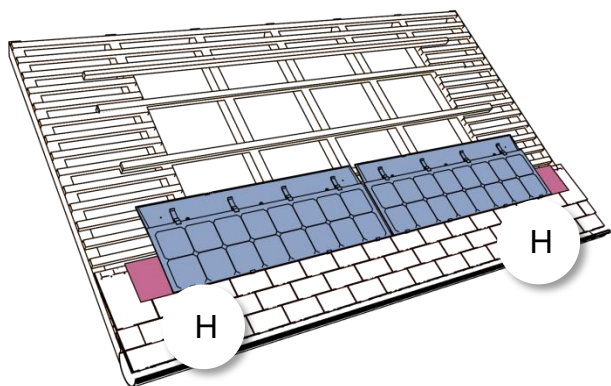

# 4. AJUSTEMENT DES PREMIERS COULOIRS LATÉRAUX

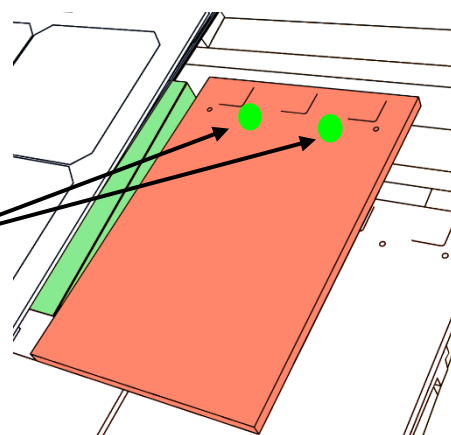
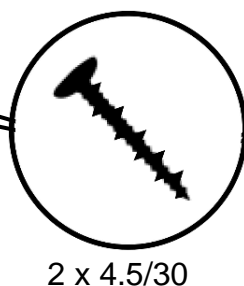
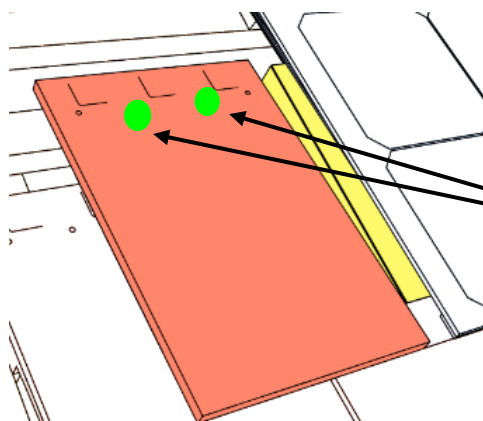
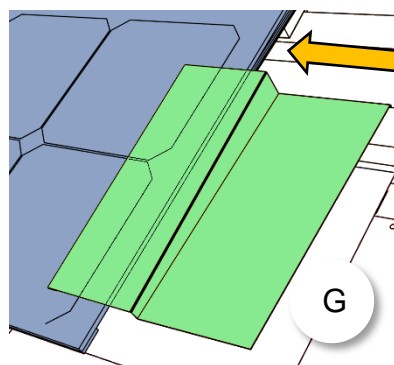
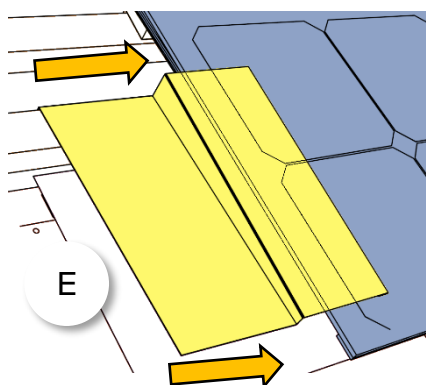
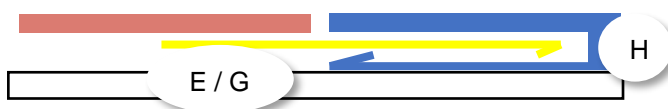
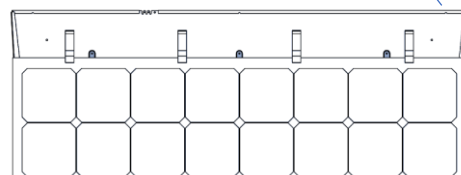
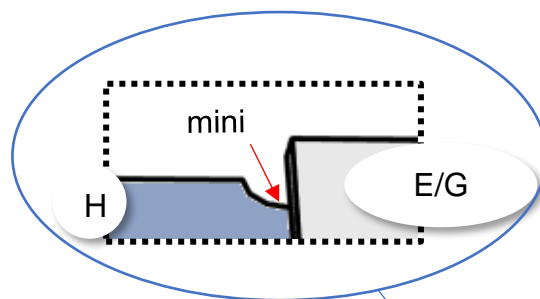
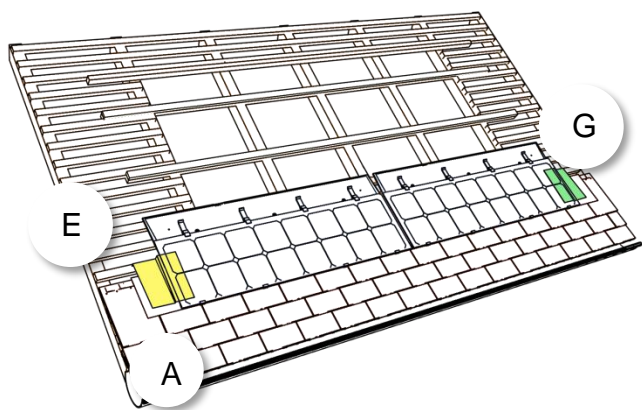

## 5. POSE DES RALLONGES ELECTRIQUES

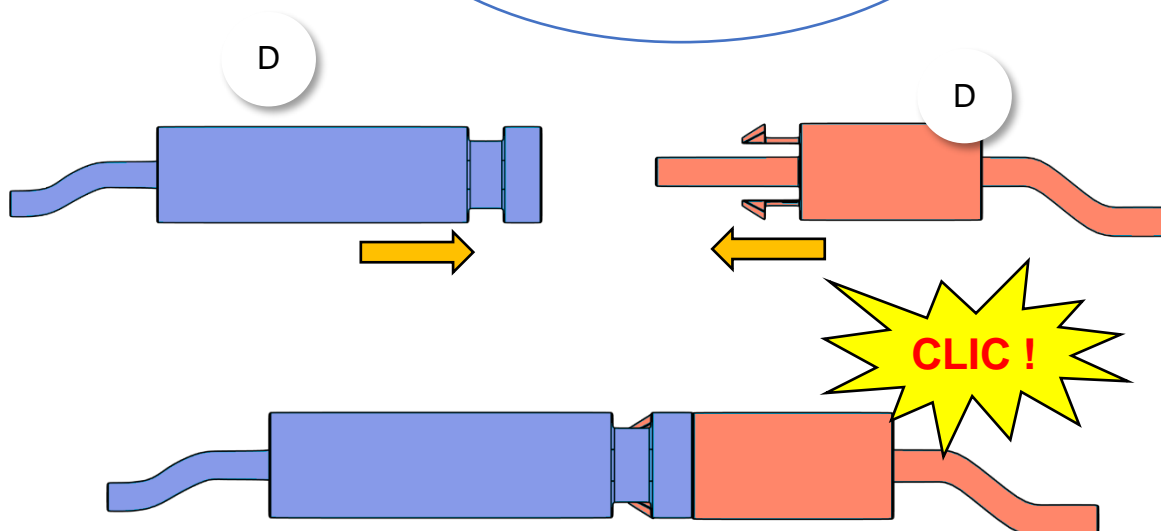
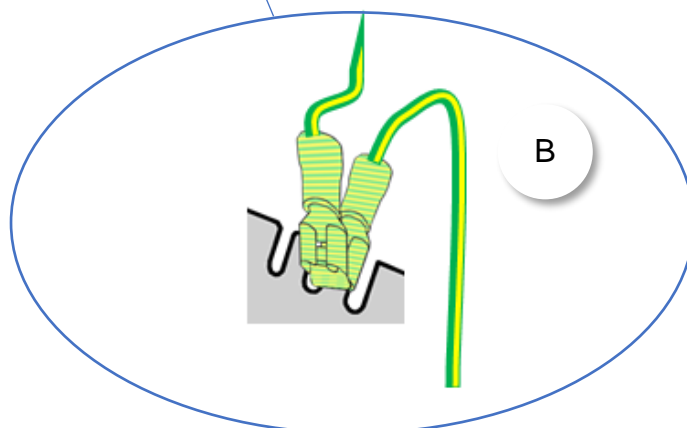
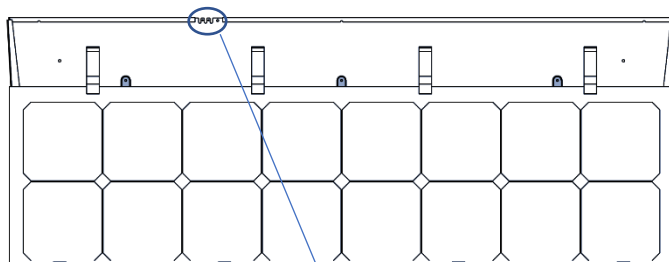
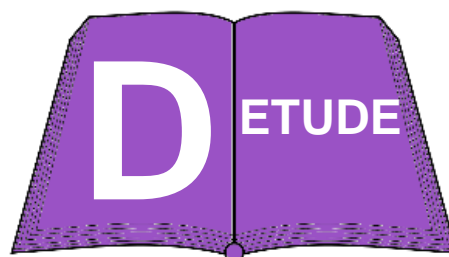
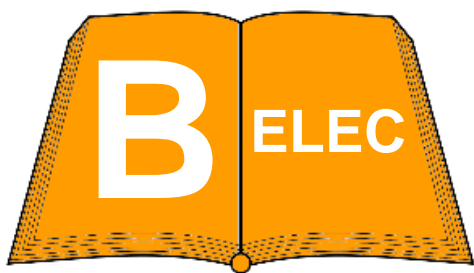

Penser à tirer les rallonges avant de poser la deuxième ligne



## 6. POSE DES LIGNES SUPPLEMENTAIRES

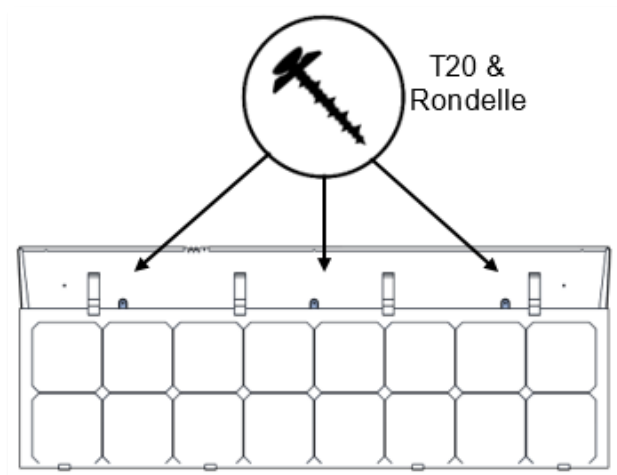
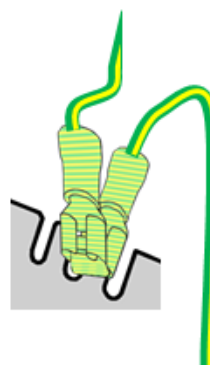
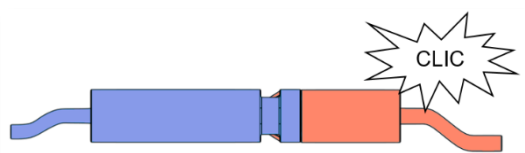
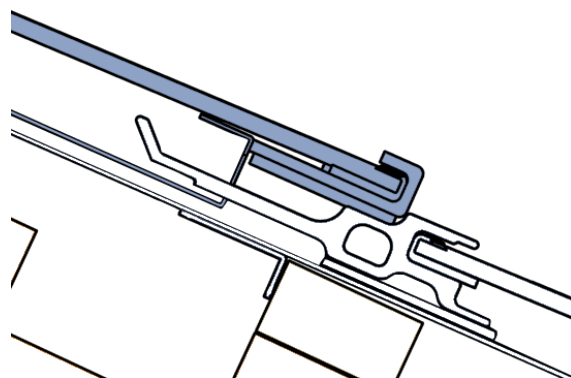
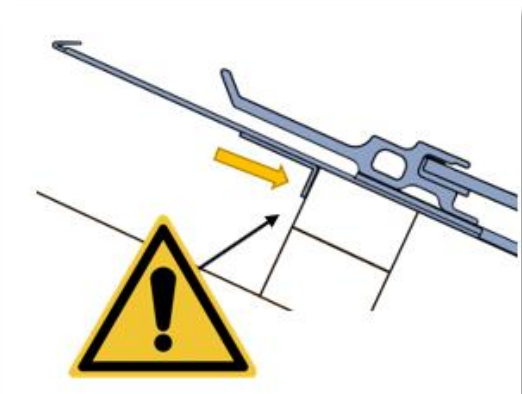
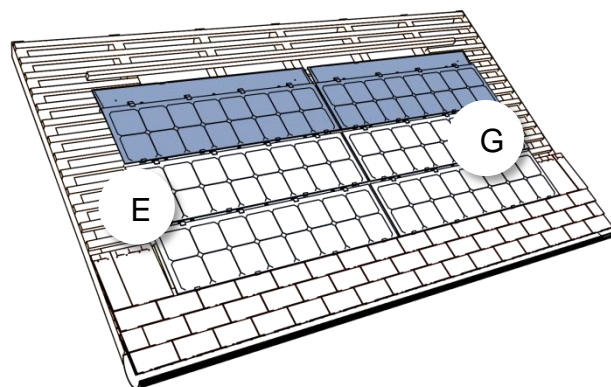
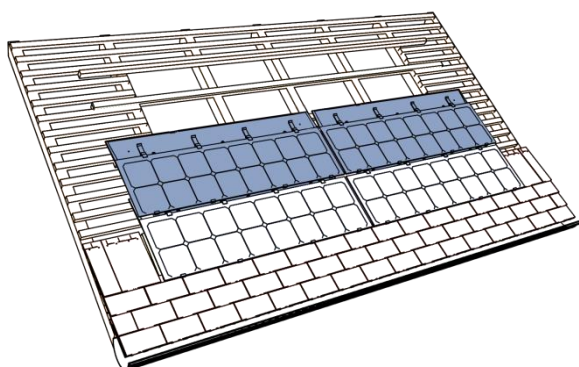

Répéter ces opérations  
pour chaque ligne  
supplémentaire

# 7. POSE DES ABERGEMENTS

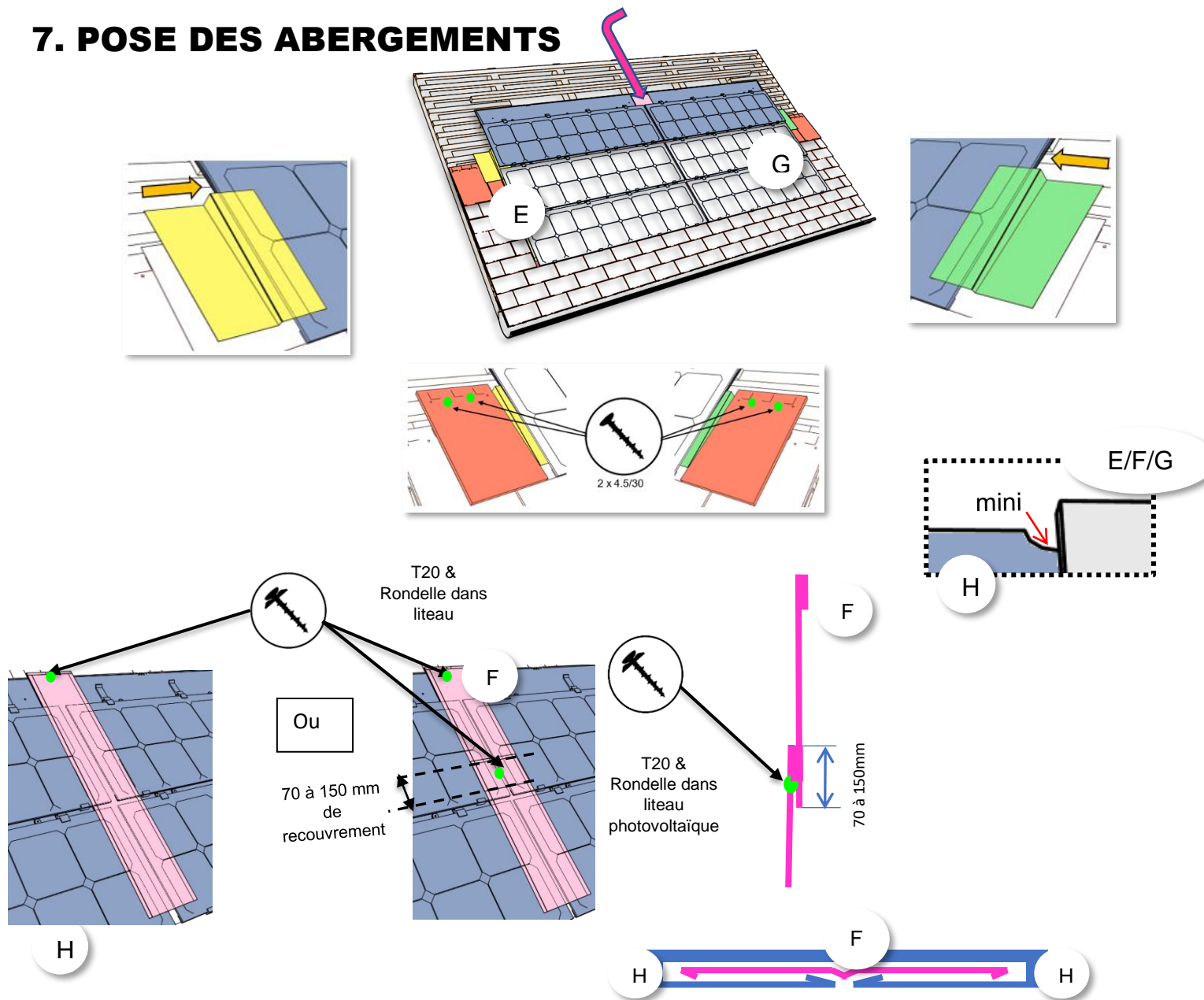

# 8. NOQUETS HAUTS LATÉRAUX

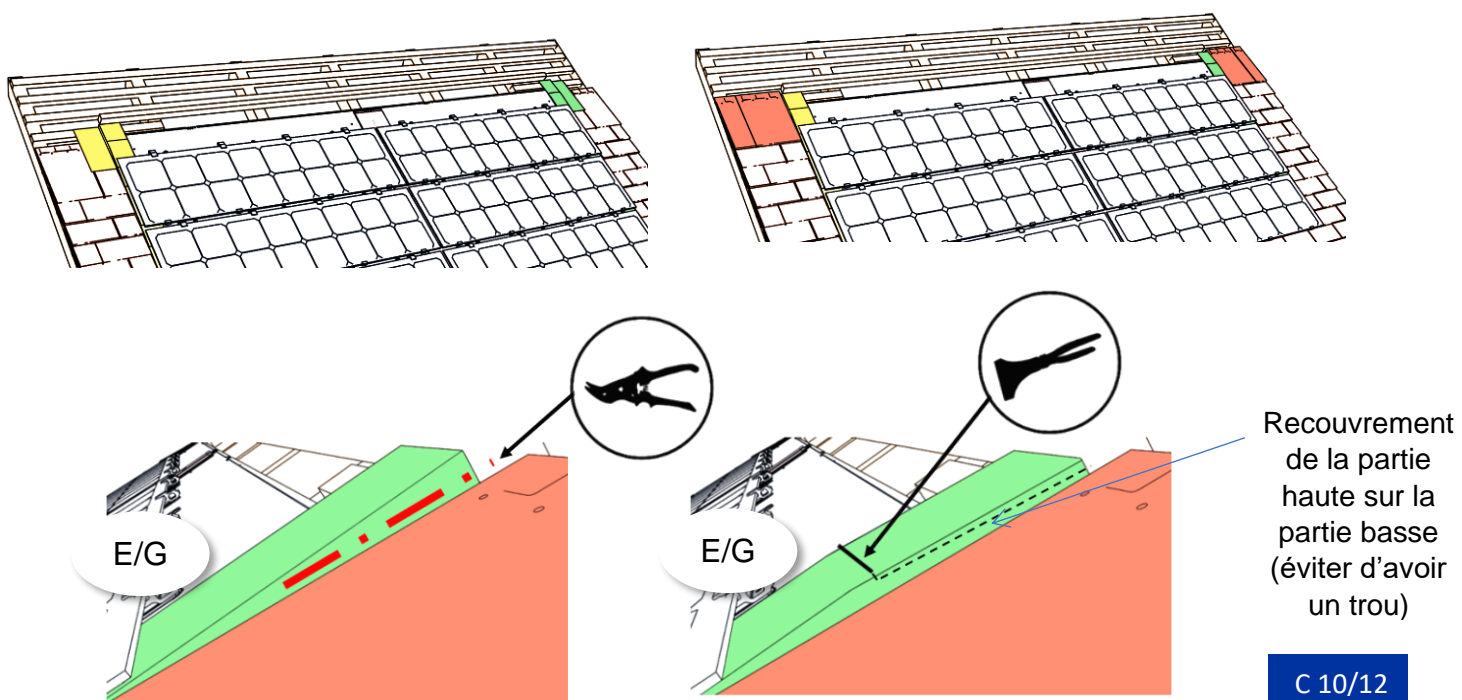

# 9. POSE DES BAVETTES HAUTES

## + TUILES AU-DESSUS DU CHAMP PHOTOVOLTAÏQUE

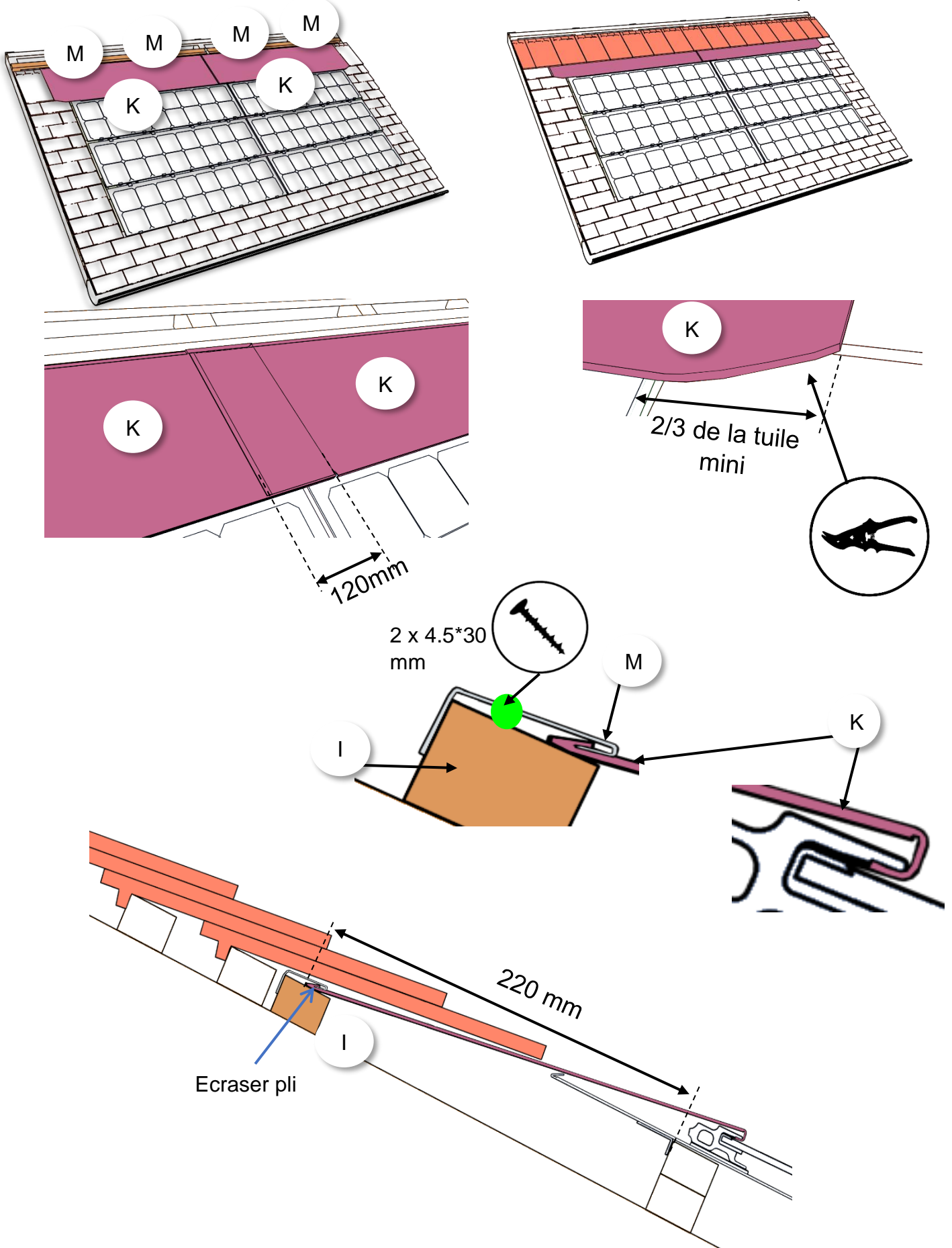



## 10. FIXATION DES TUILES AUTOUR DU CHAMP PV

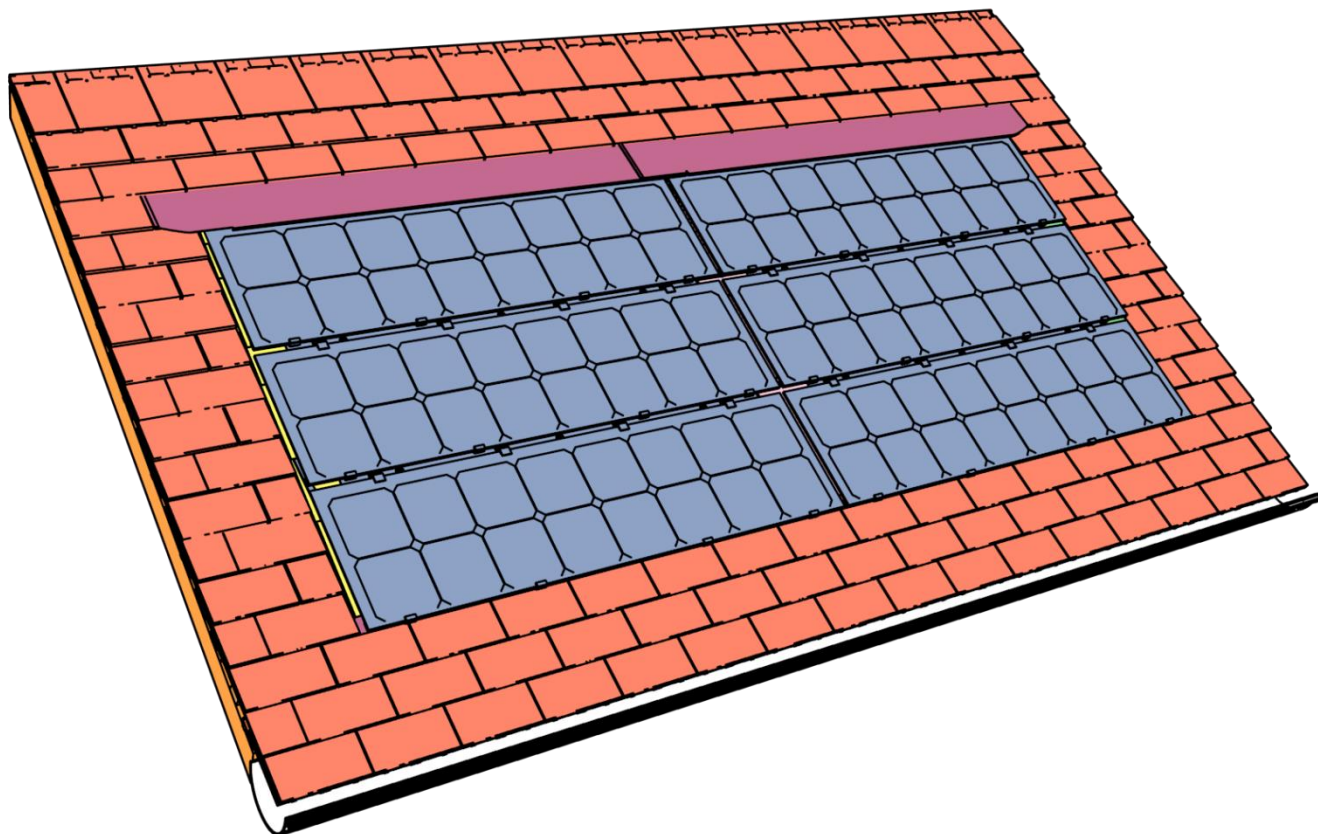
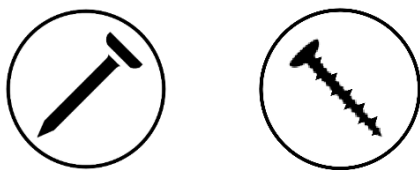

**EDILIANS Site d'ARNAS**  
3, Impasse de Chavanne  
69400 ARNAS  
Hotline : 0810 148 223  
Email : [be.solaire@edilians.com](mailto:be.solaire@edilians.com)

