

\*1546S\_1  
546\*

edilians.com

NOS SOLUTIONS



# PM

## NOTICE DE MONTAGE

C-PM-15/11/2021





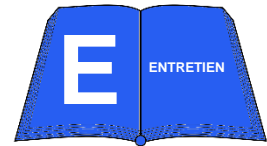
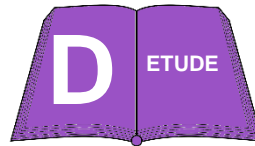
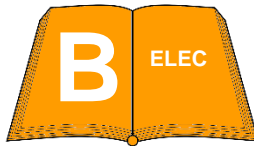

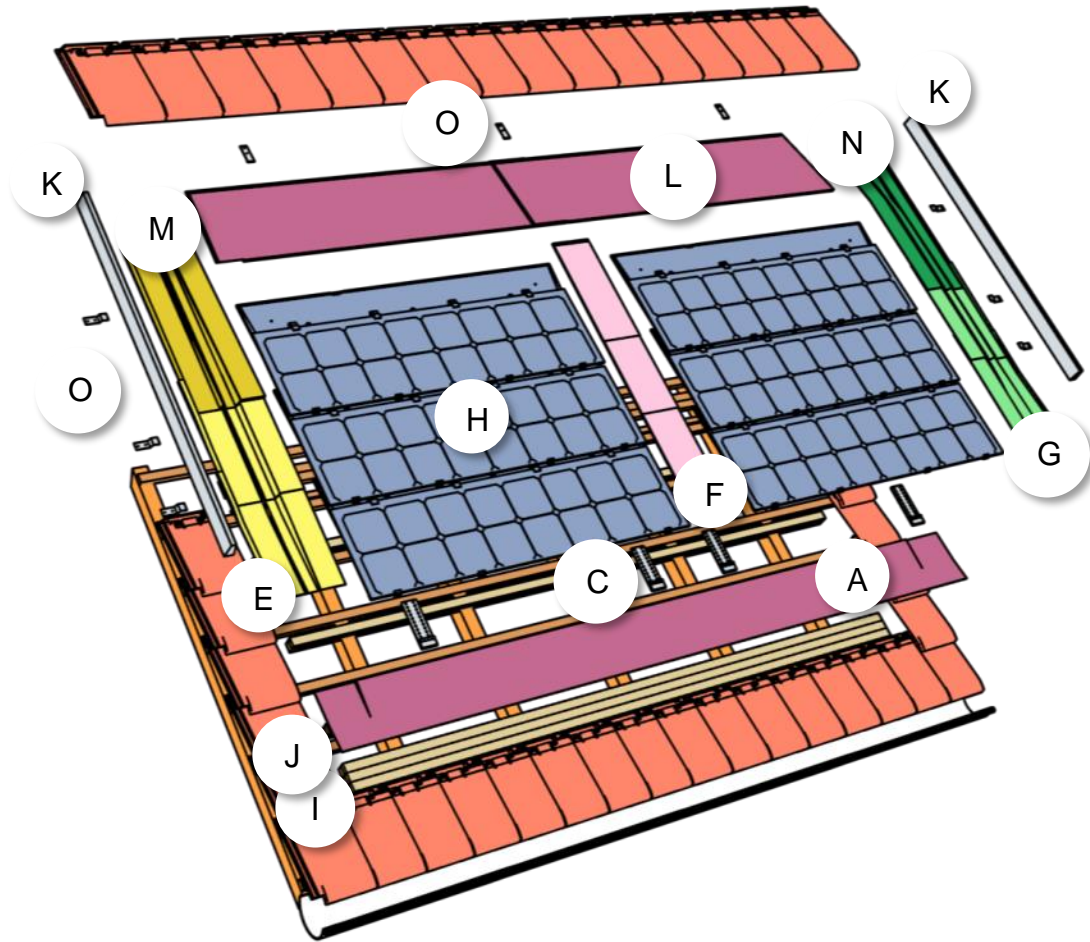

Tutoriel vidéo : <https://youtu.be/jydCHguZRDY>

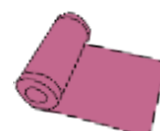

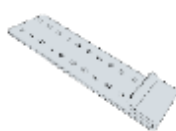

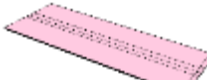
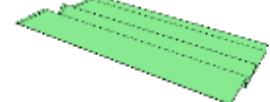
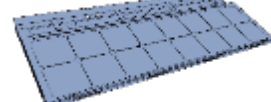
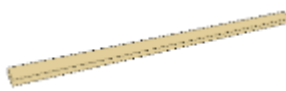
# NOMENCLATURE

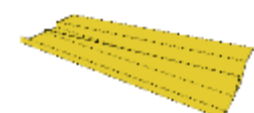
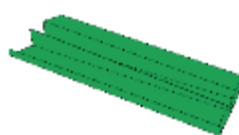
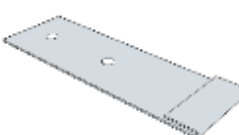

- |   |  |  |
|---|--|--|
| <p><b>A</b> </p> <p>Bavette souple basse</p>                     | <p><b>B</b> </p> <p>Câble de terre / Double cosse</p> | <p><b>C</b> </p> <p>Crochet</p>           |
| <p><b>D</b> </p> <p>Connecteurs</p>                              | <p><b>E</b> </p> <p>Couloir gauche</p>                | <p><b>F</b> </p> <p>Couloir central</p>   |
| <p><b>G</b> </p> <p>Couloir droit</p>                            | <p><b>H</b> </p> <p>Tuile photovoltaïque</p>          | <p><b>I</b> </p> <p>Liteau 20 x 40 mm</p> |
| <p><b>J</b> </p> <p>Liteau identique au liteau de couverture</p> | <p><b>K</b> </p> <p>Mousse triangle</p>               | <p><b>L</b> </p> <p>Bavette haute</p>     |
| <p><b>M</b> </p> <p>Couloir gauche partie haute</p>              | <p><b>N</b> </p> <p>Couloir droit partie haute</p>    | <p><b>O</b> </p> <p>Agrafe</p>            |

## 2.1 Implantation champ PV + liteaux (longitudinal)

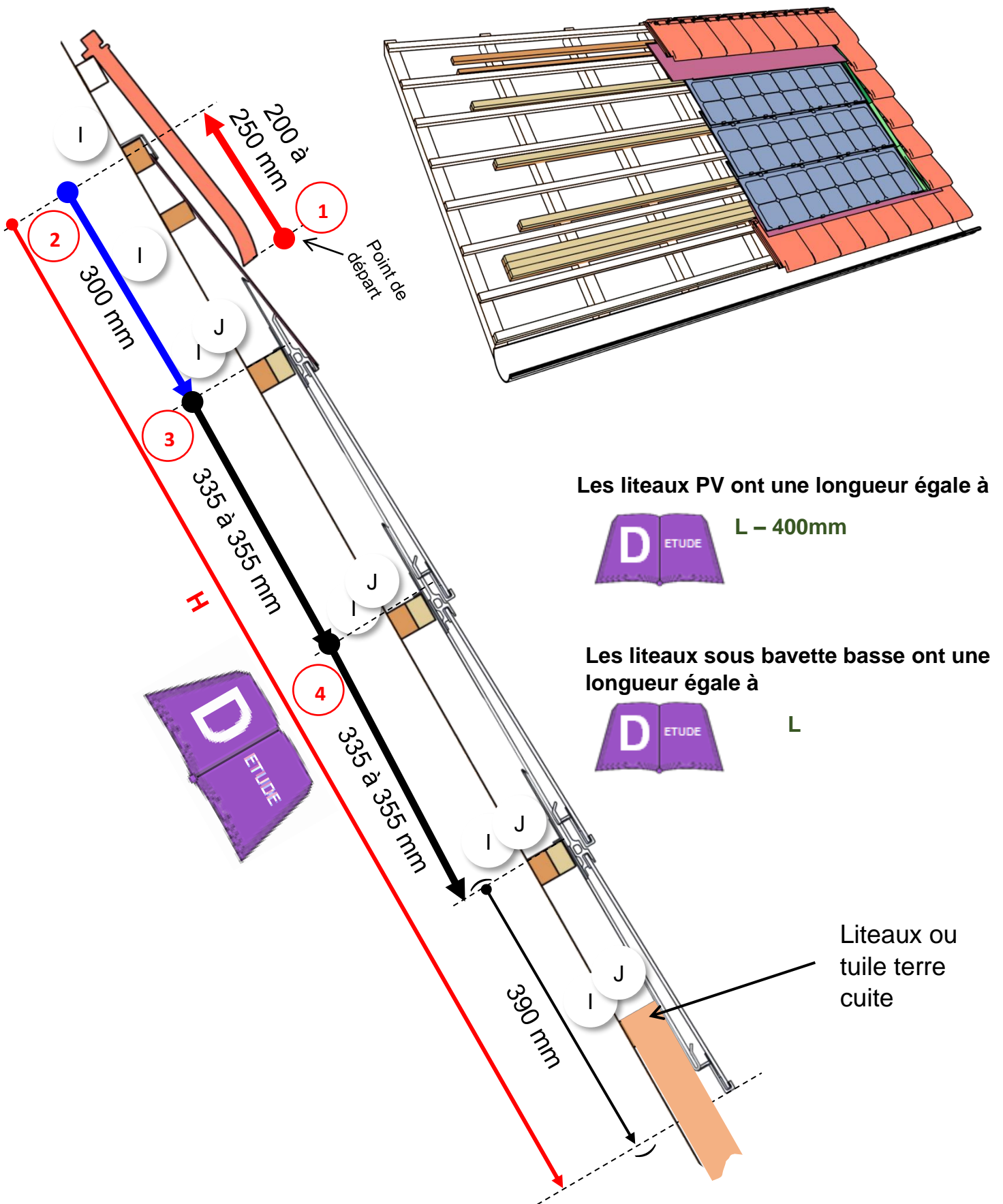



## 2.2 Implantation champ PV (lateral)

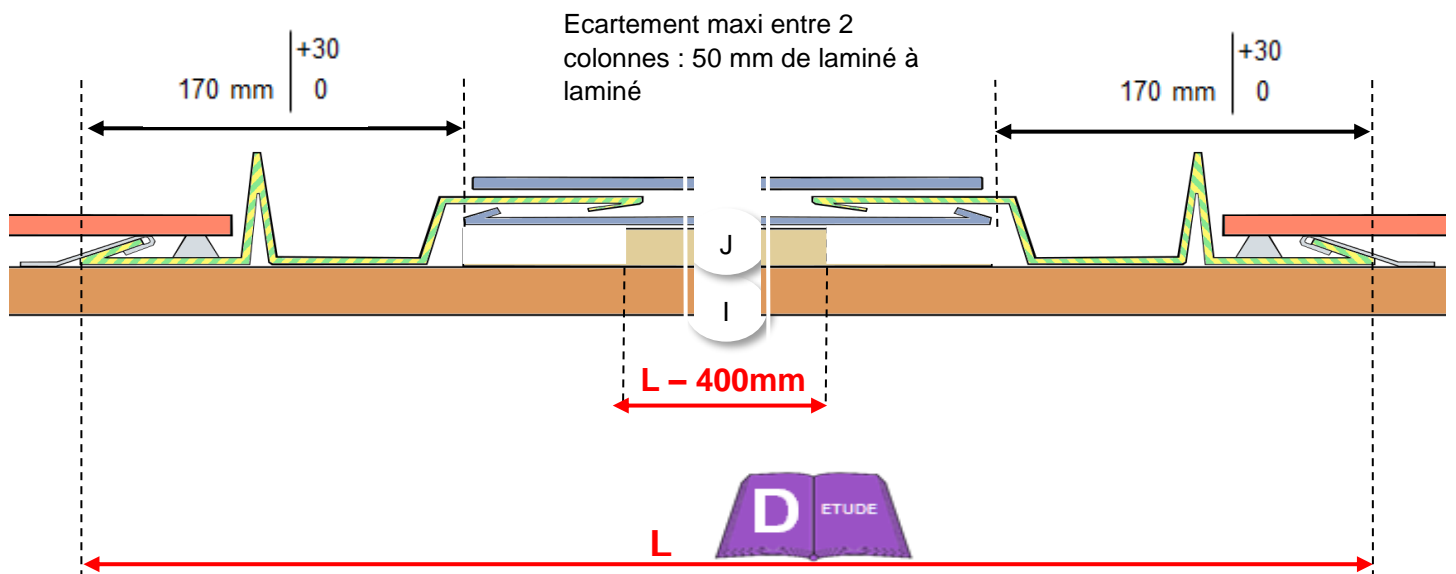
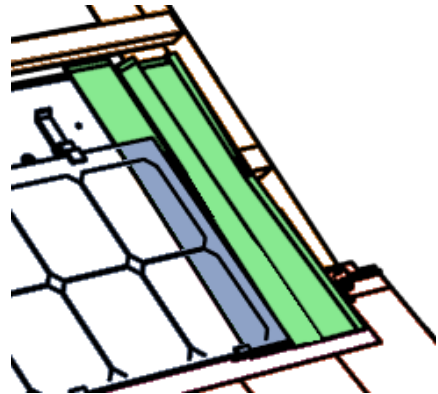
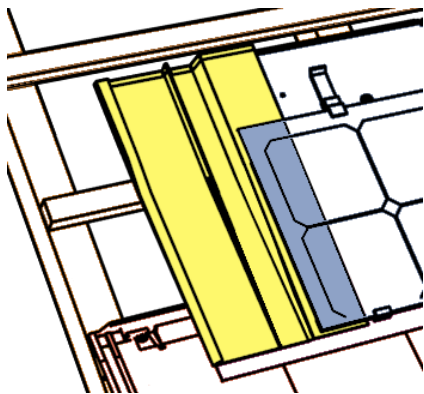
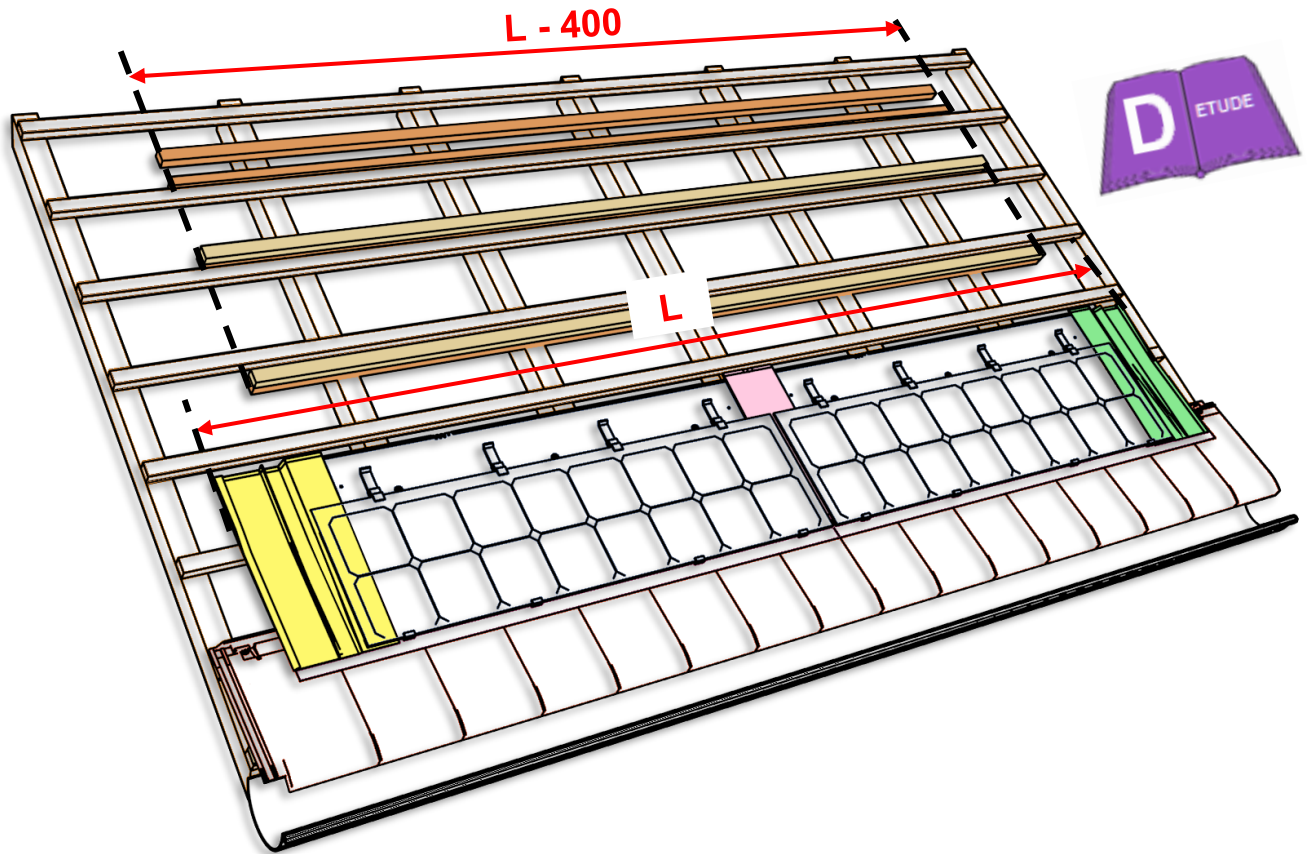

### 3. FIXATION DES CROCHETS D'EGOUT

#### Cas 1 : Pose à l'égout

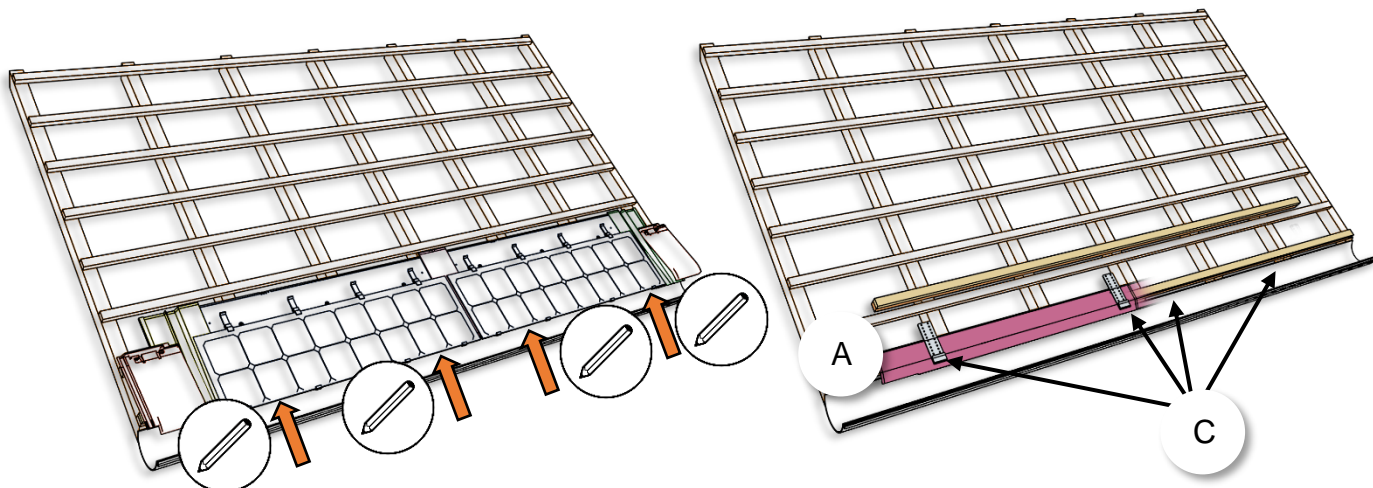

Présenter la ligne du bas du champ photovoltaïque sur la toiture, positionner les produits de couverture à chaque extrémité puis, repérer la position des crochets d'égout en face des encoches à droite et à gauche du châssis.

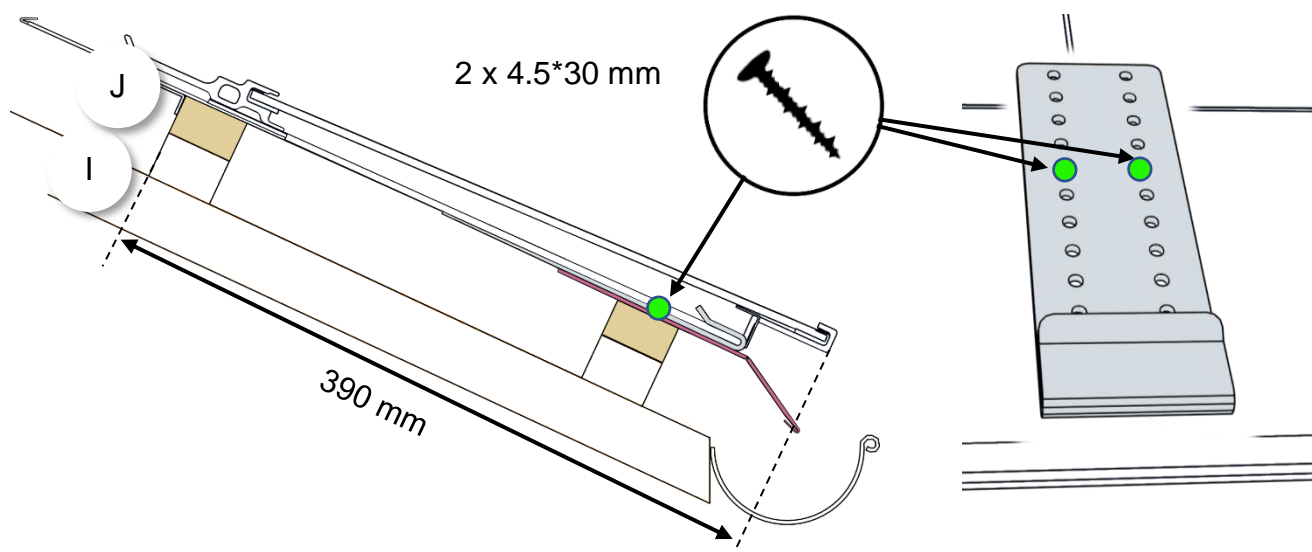
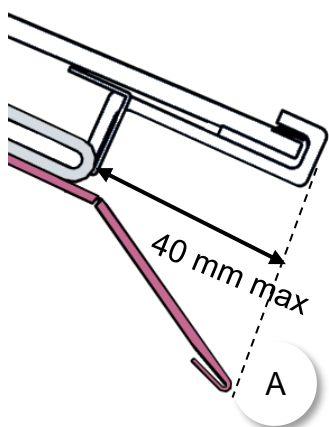

## Cas 2 : Pose en plain carré

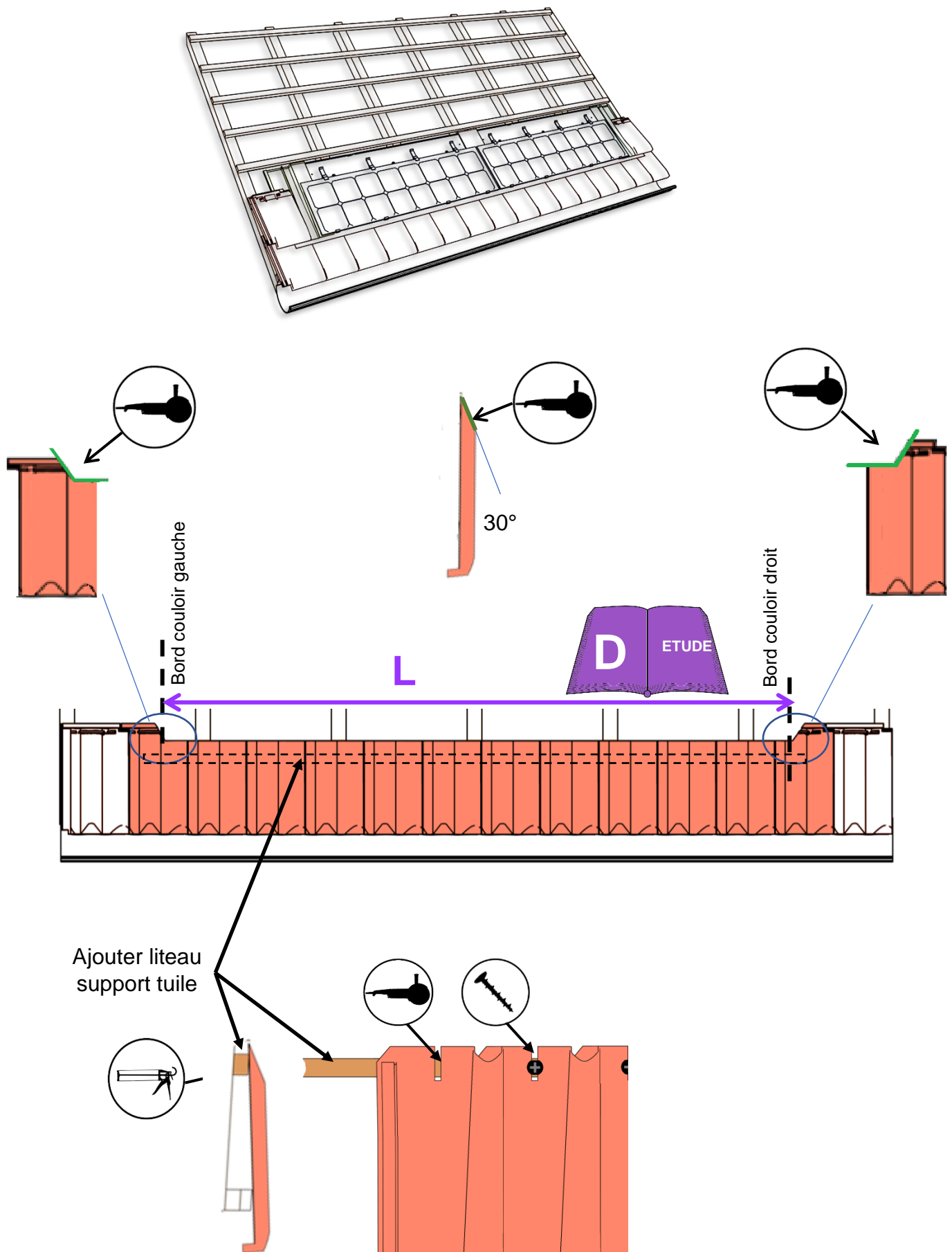

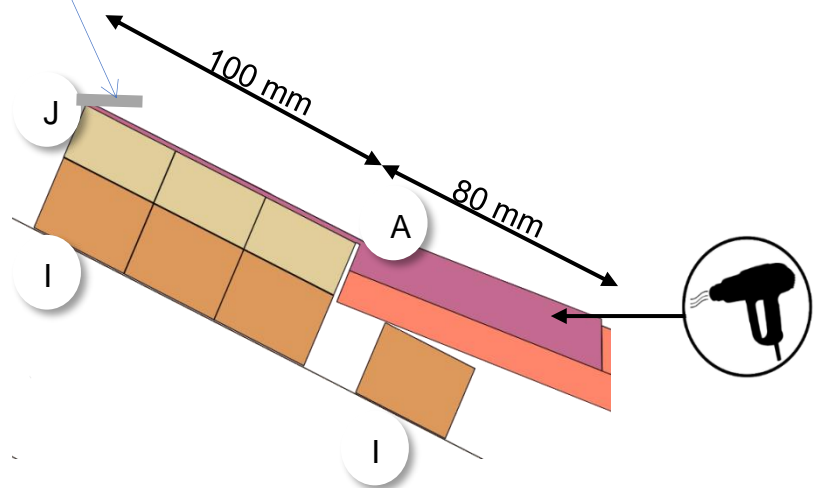
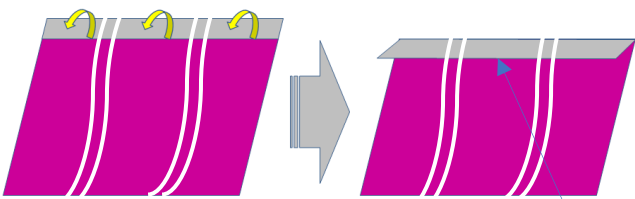
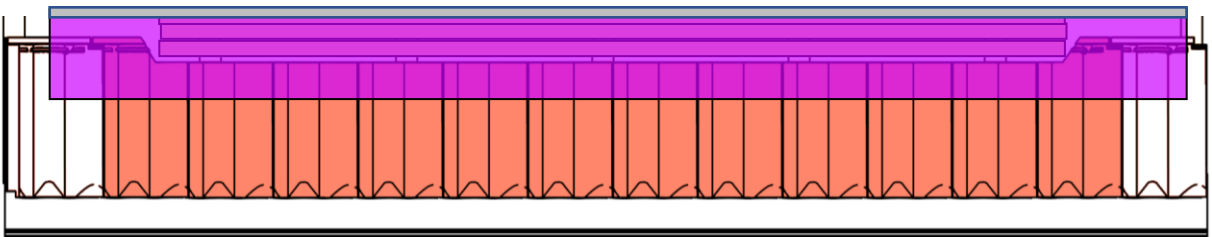
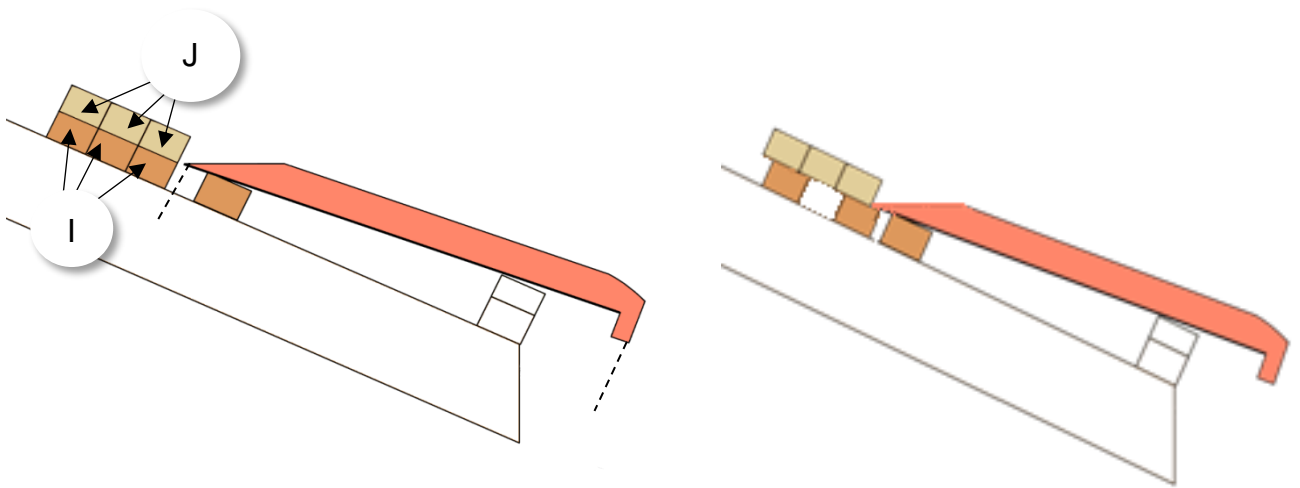
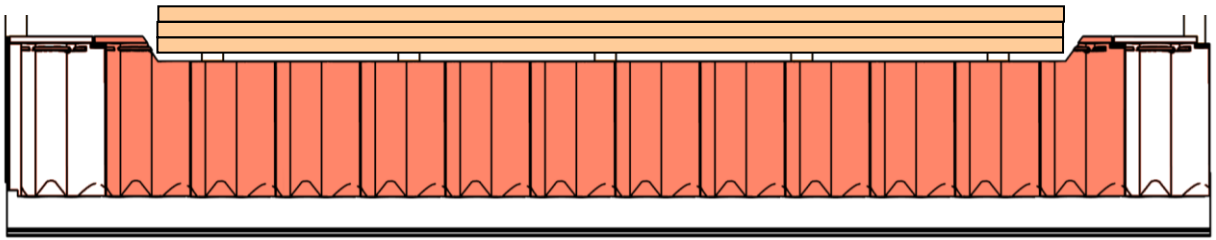

### 3.2 Fixation des crochets d'égout

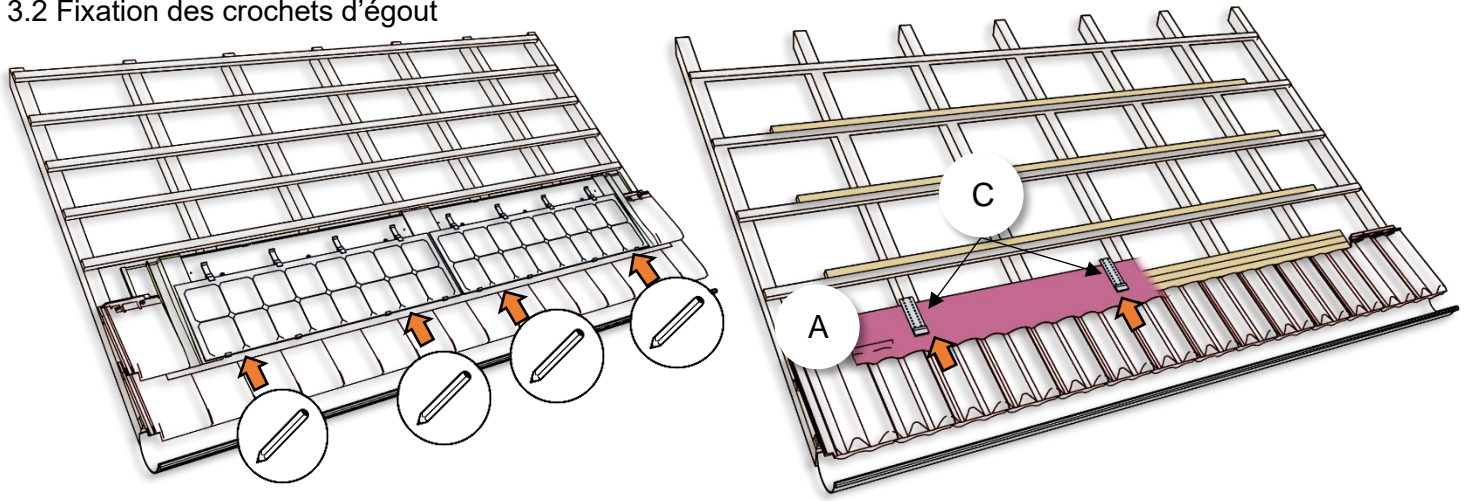

Présenter la ligne du bas du champ photovoltaïque sur la toiture, positionner les produits de couverture à chaque extrémité puis, repérer la position des crochets d'égout en face des encoches à droite et à gauche du châssis.

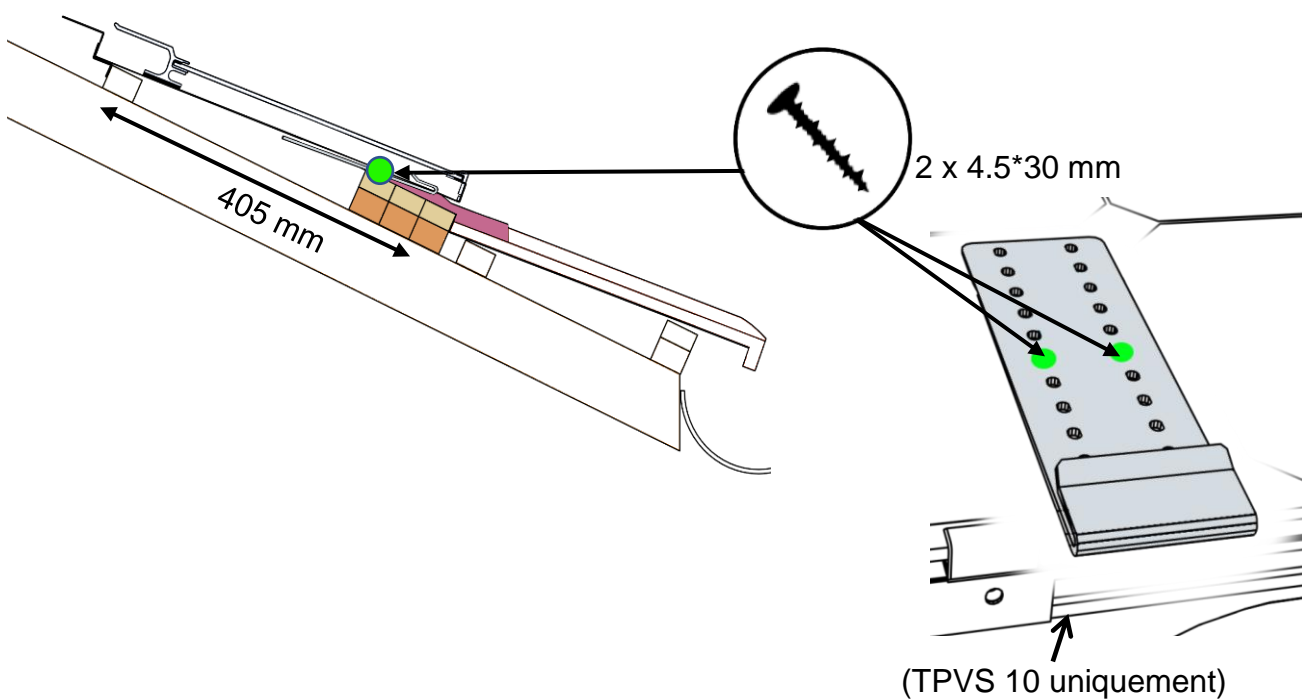
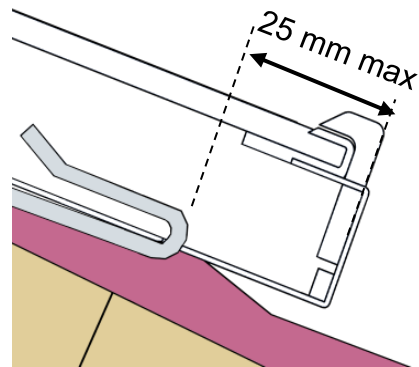



## 4. POSE DE LA PREMIERE LIGNE TUILE PHOTOVOLTAÏQUE

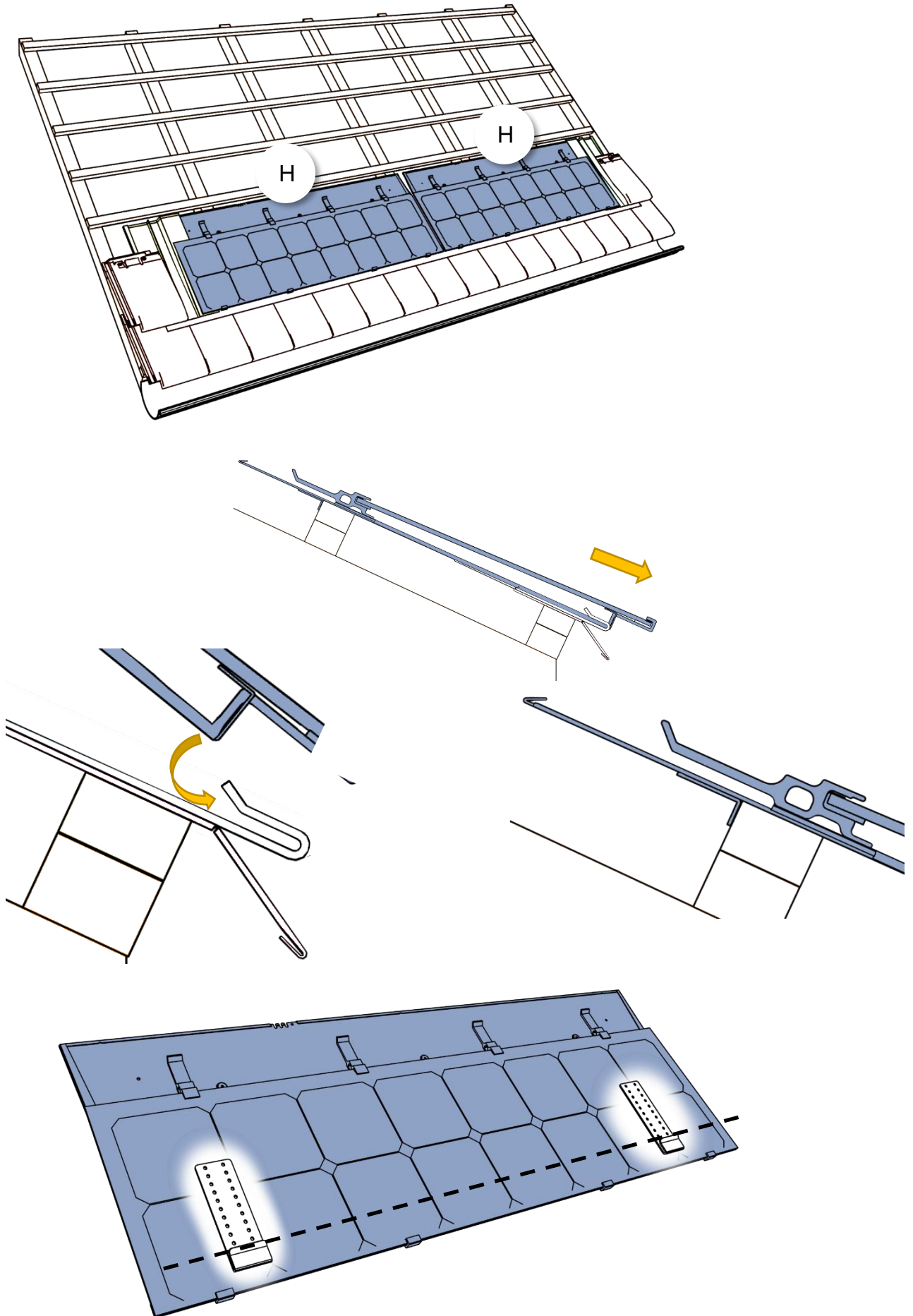

## 5. AJUSTEMENT DU CHAMP PV

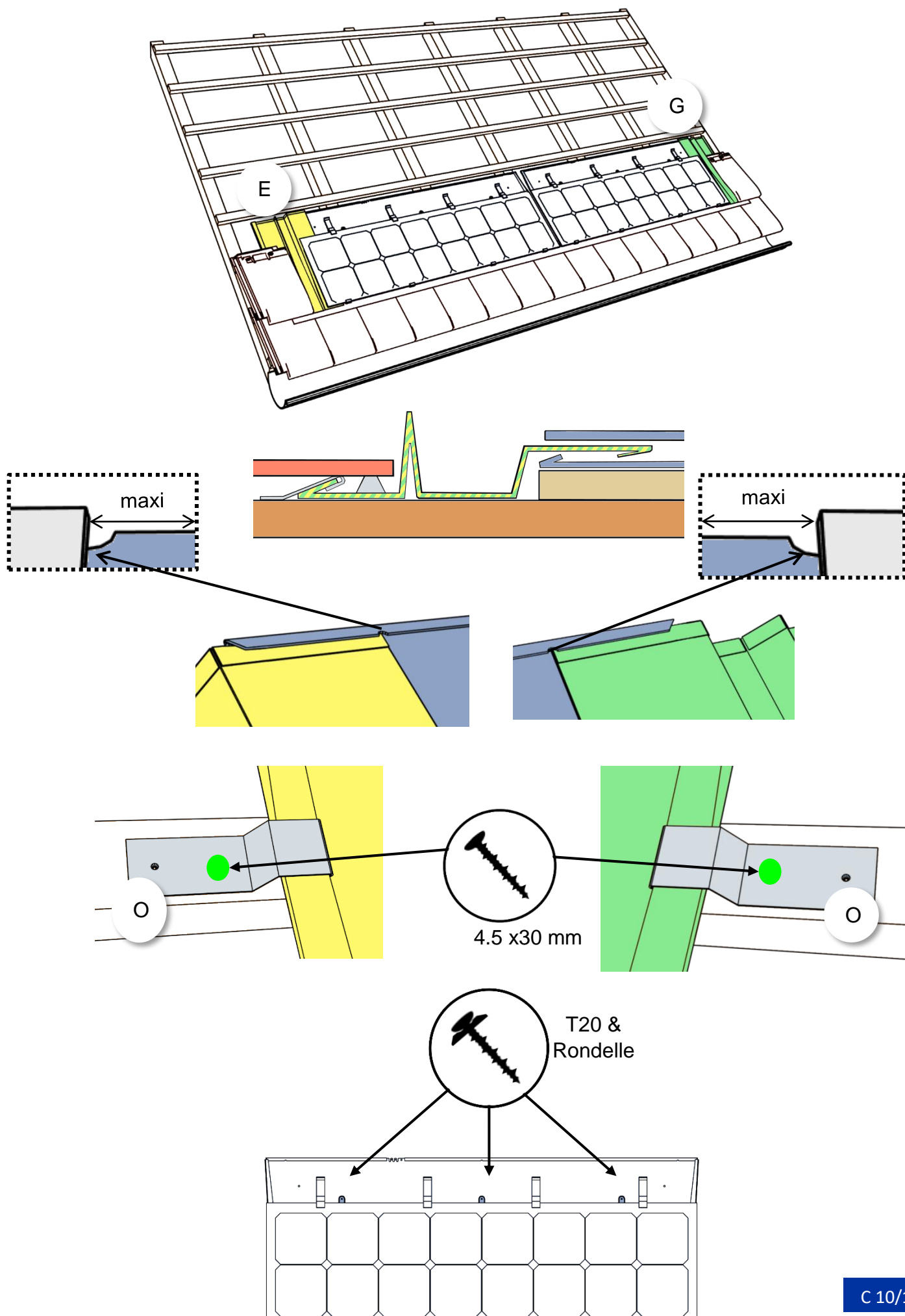

## 6. POSE DES RALLONGES ELECTRIQUES

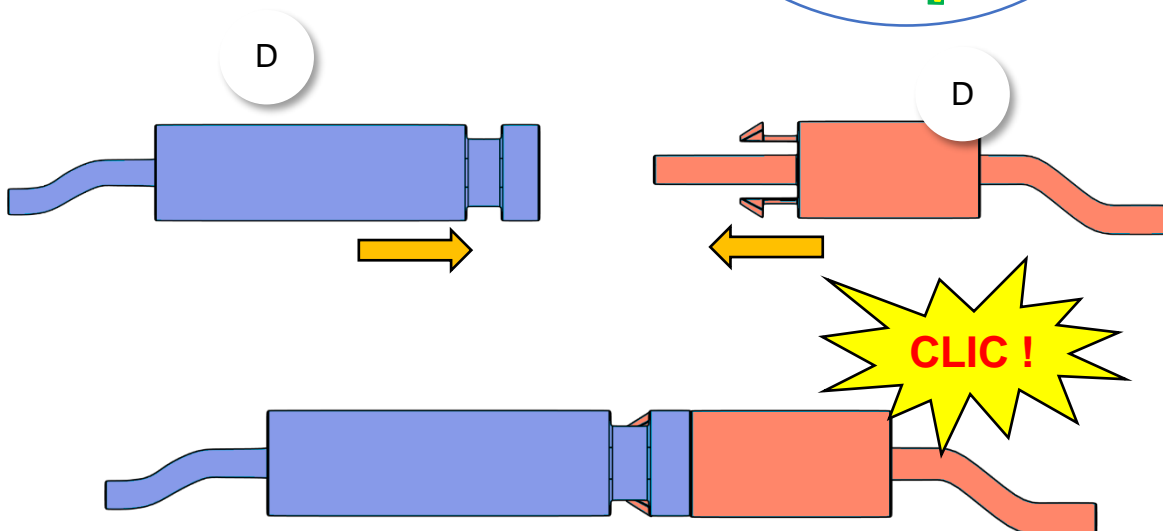
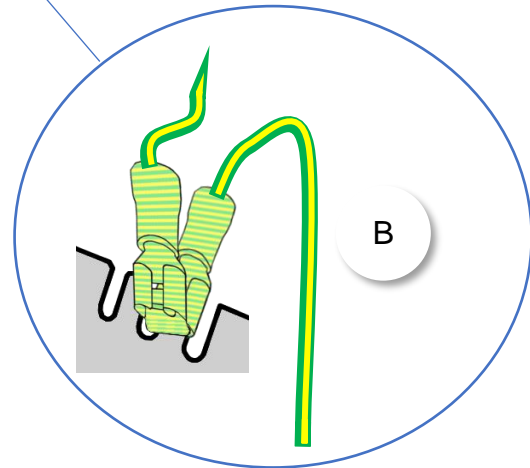
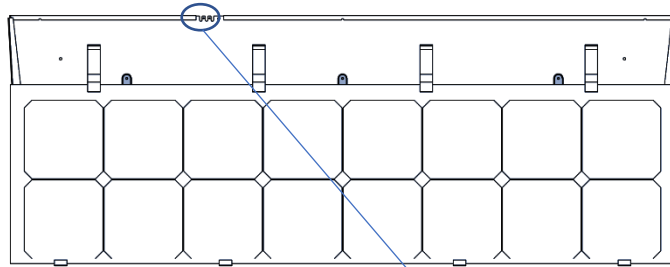
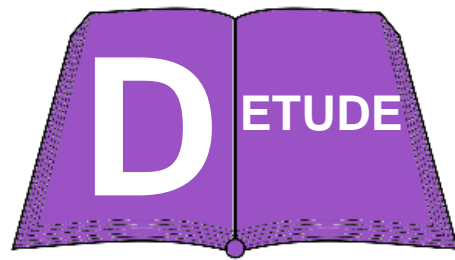
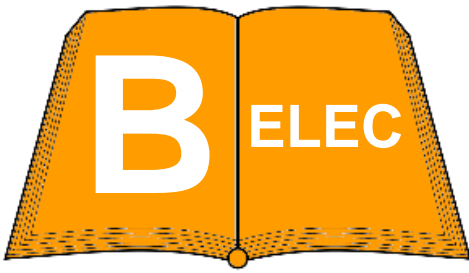

Penser à tirer les rallonges avant de poser la deuxième ligne

## 7. POSE DES LIGNES SUPPLEMENTAIRES

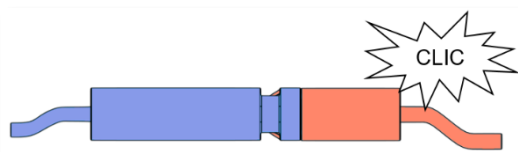
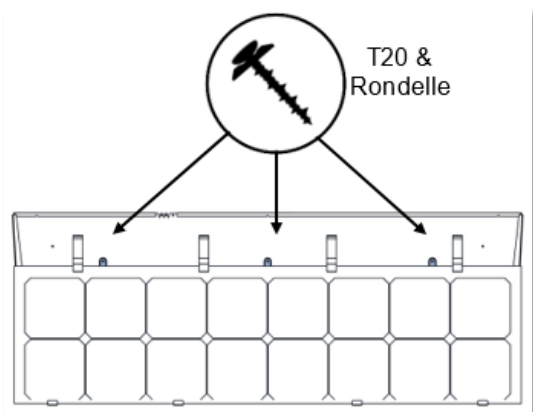
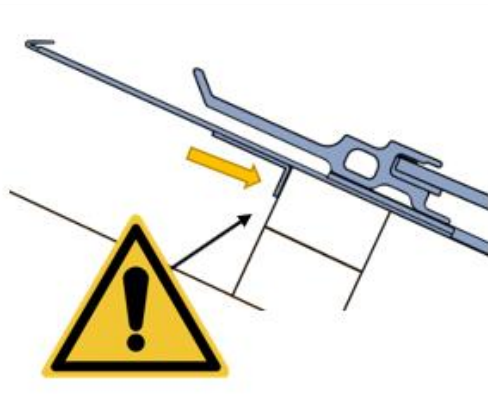
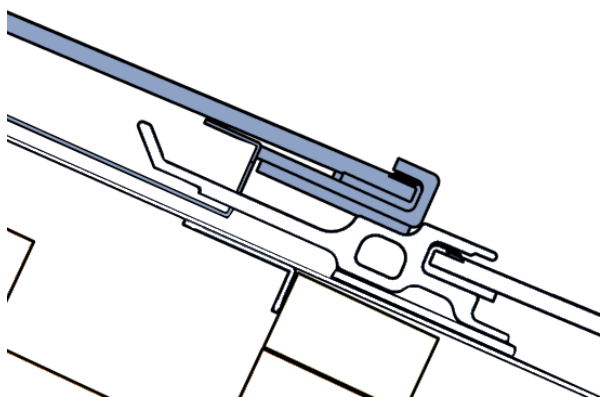
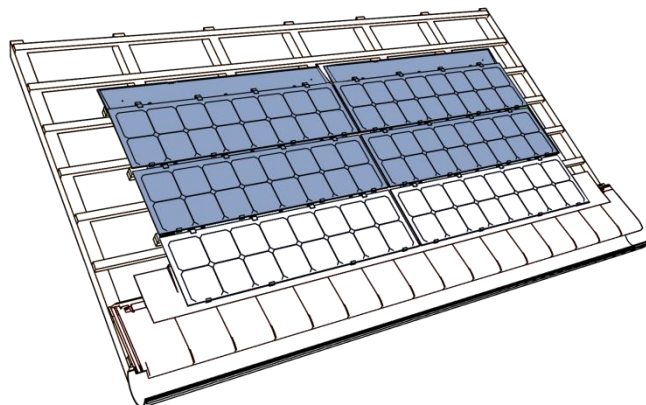
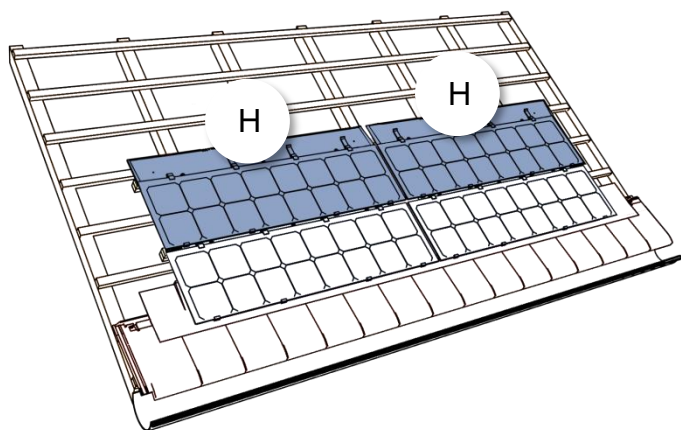

Répéter toutes ces opérations pour chaque ligne supplémentaire



# 8. POSE DES ABERGEMENTS

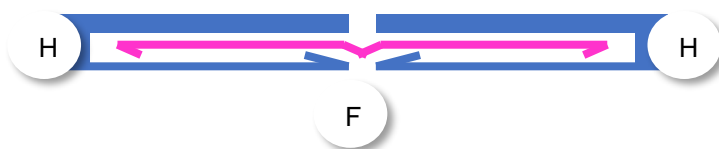
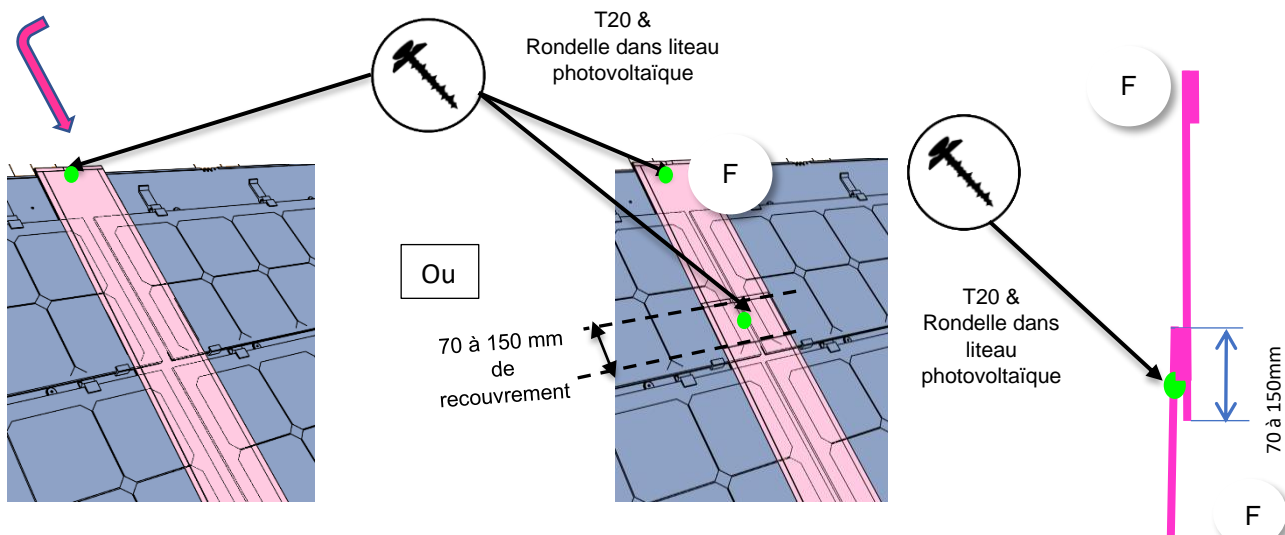
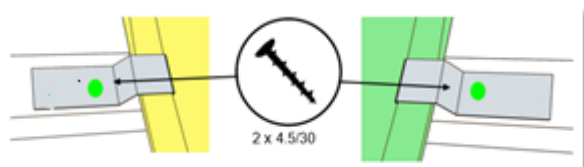
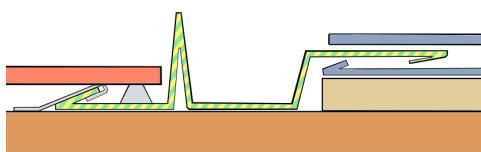
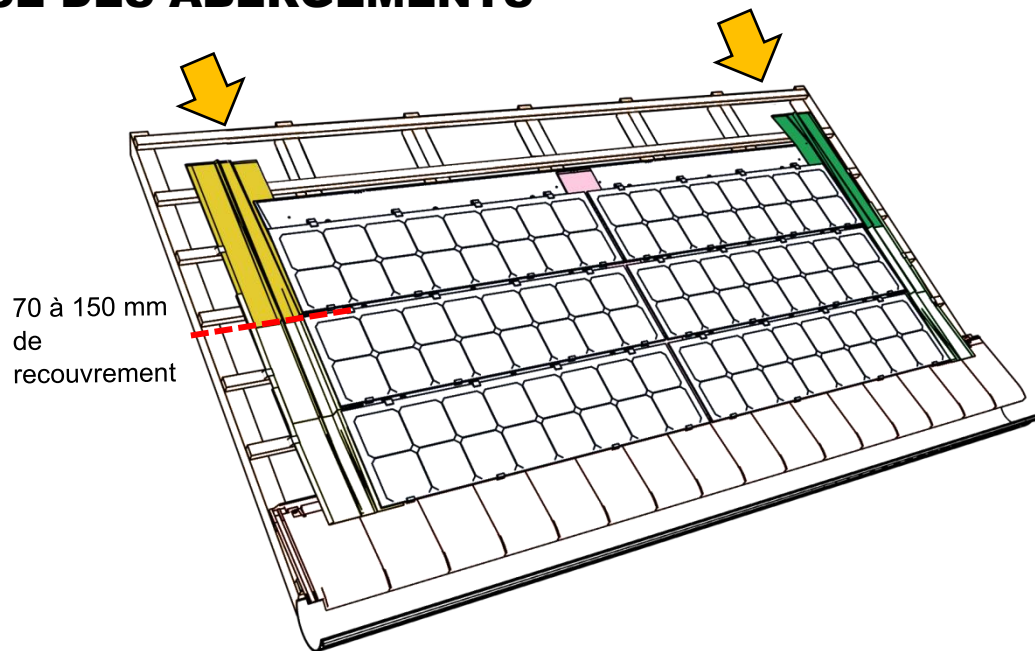

## 9. POSE DES TUILES TERRE CUITE PAR CÔTES

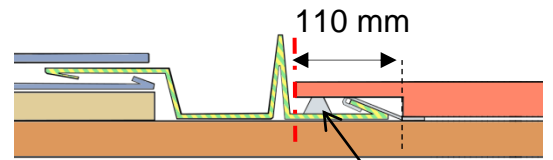
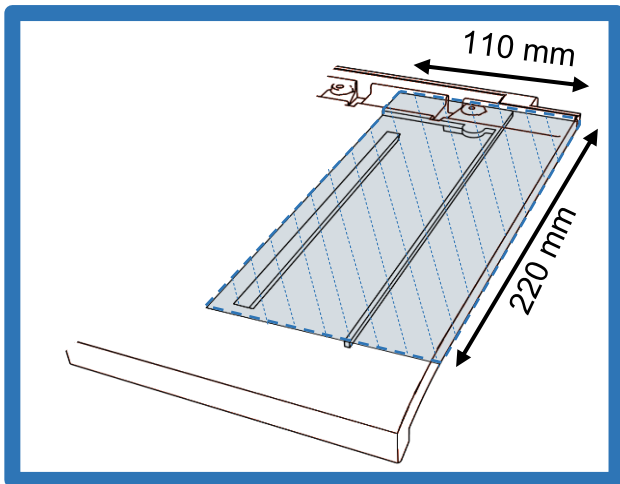

K

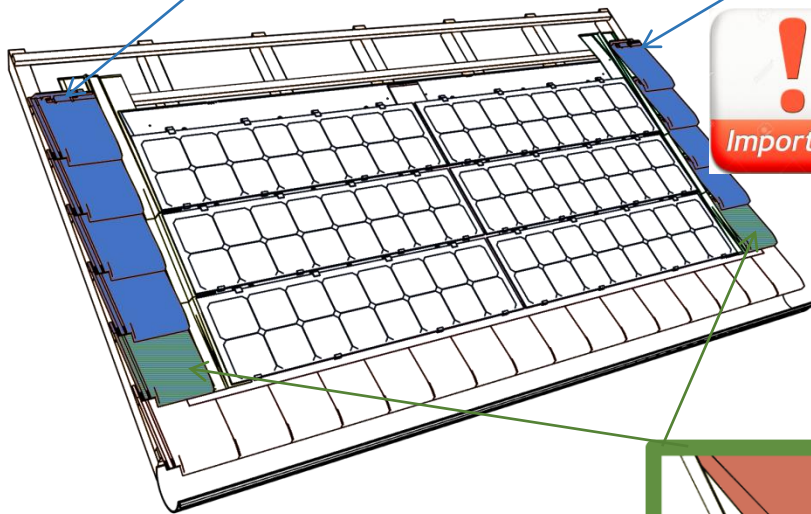
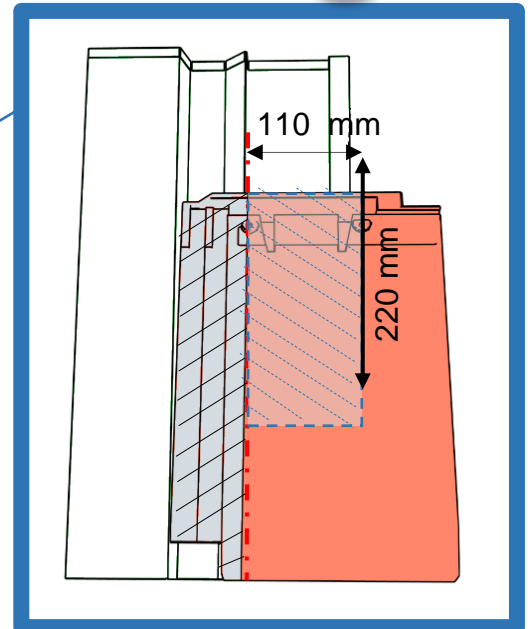
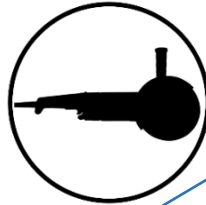

Dégager le couloir de chaque côté du champ PV

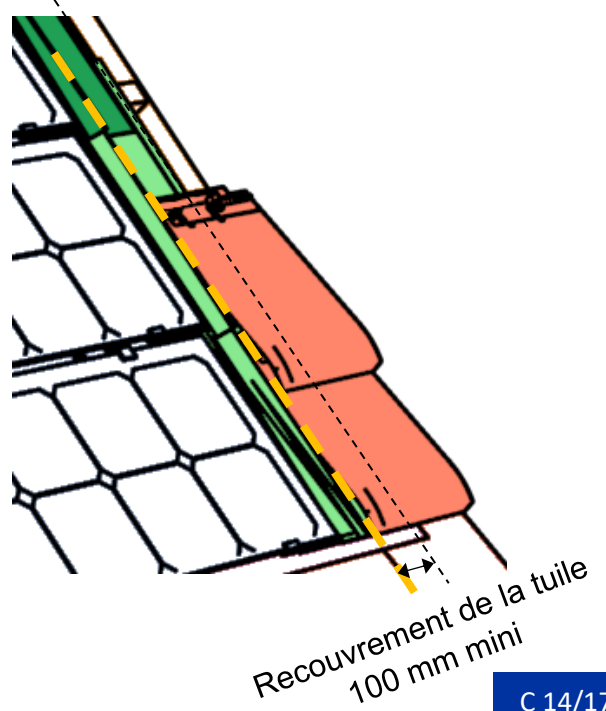
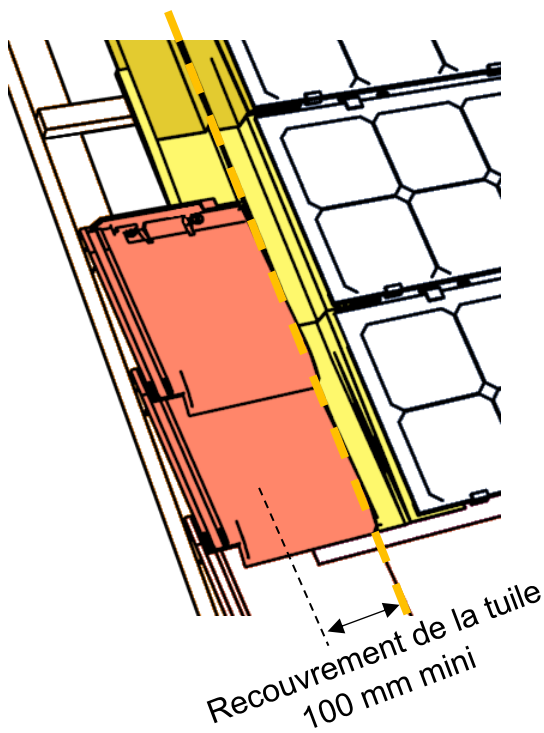
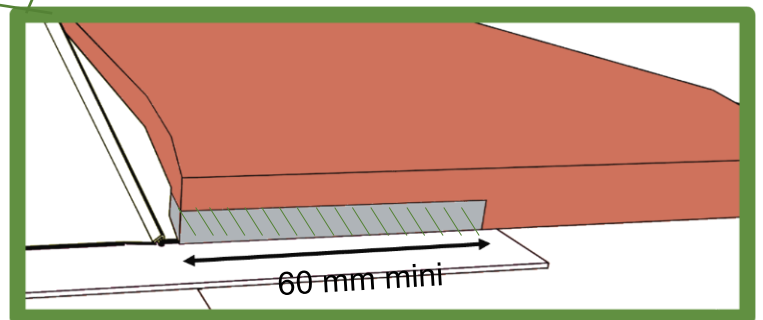

# 10. POSE BAVETTES HAUTES

## Liteau d'ajustement

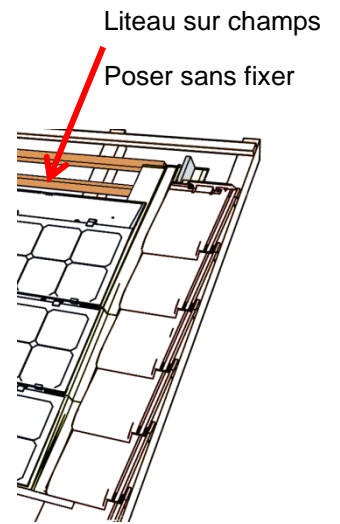
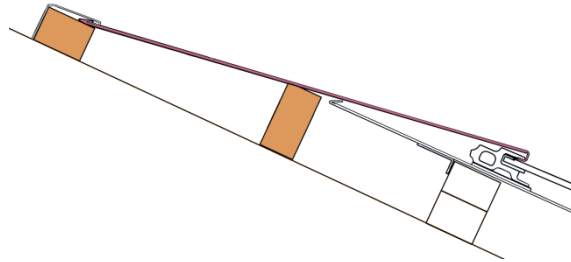
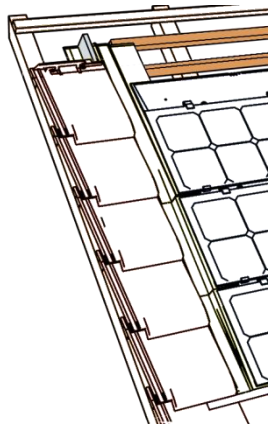

Pour ce qui suit, monter d'abord sur un seul côté jusqu'à fixation du liteau

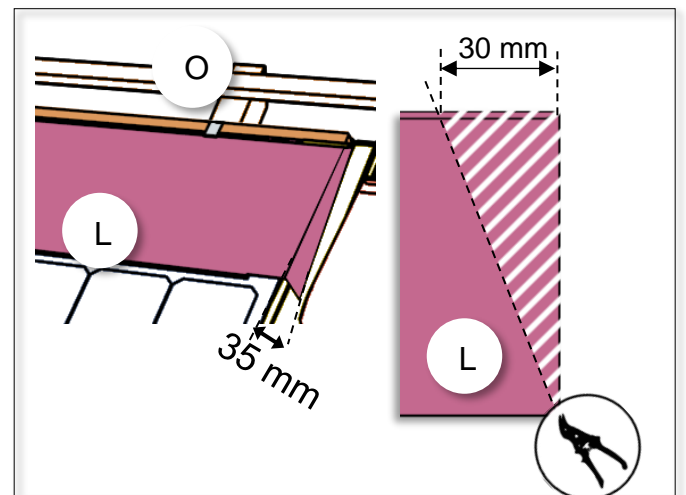
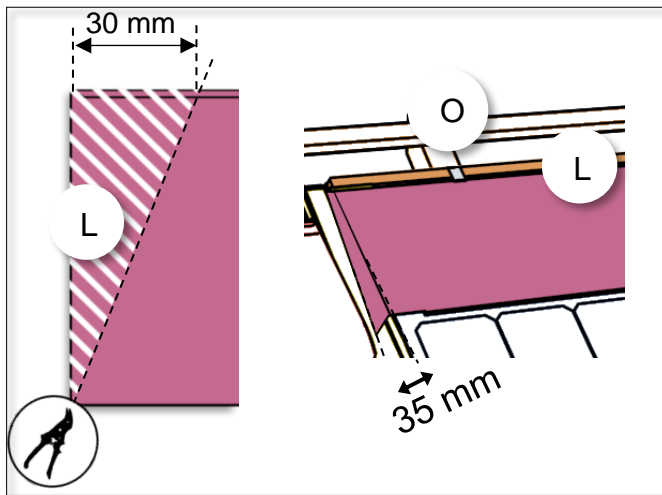

2 x 4.5\*30 mm

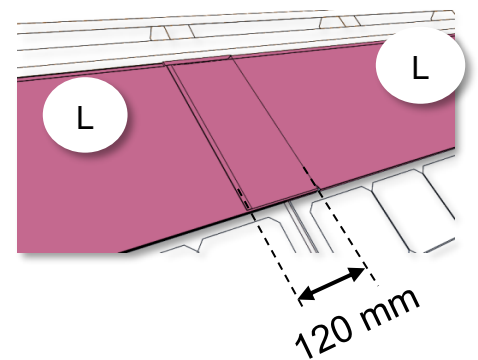
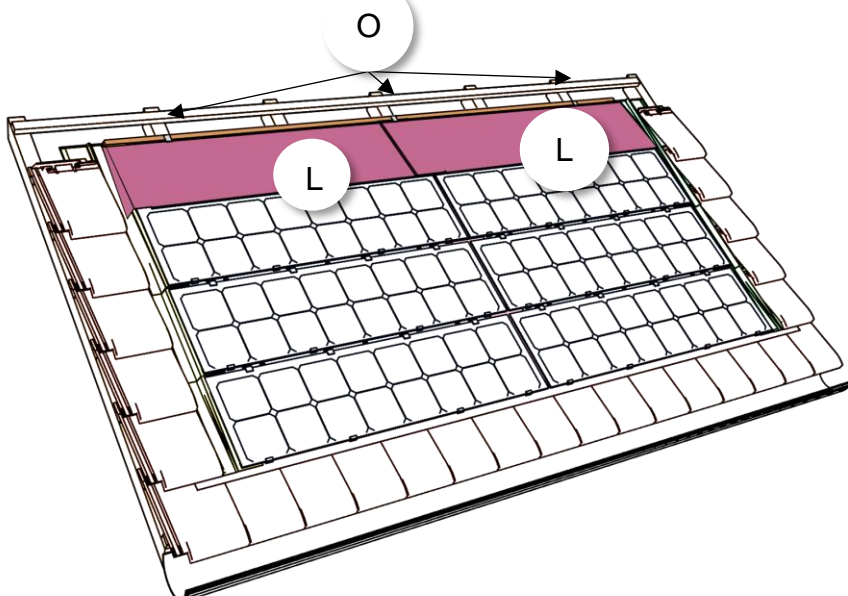
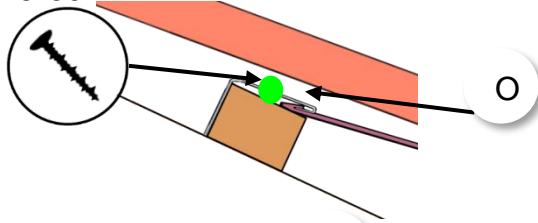

## 11. POSE DES TUILES AU-DESSUS DU CHAMP PV

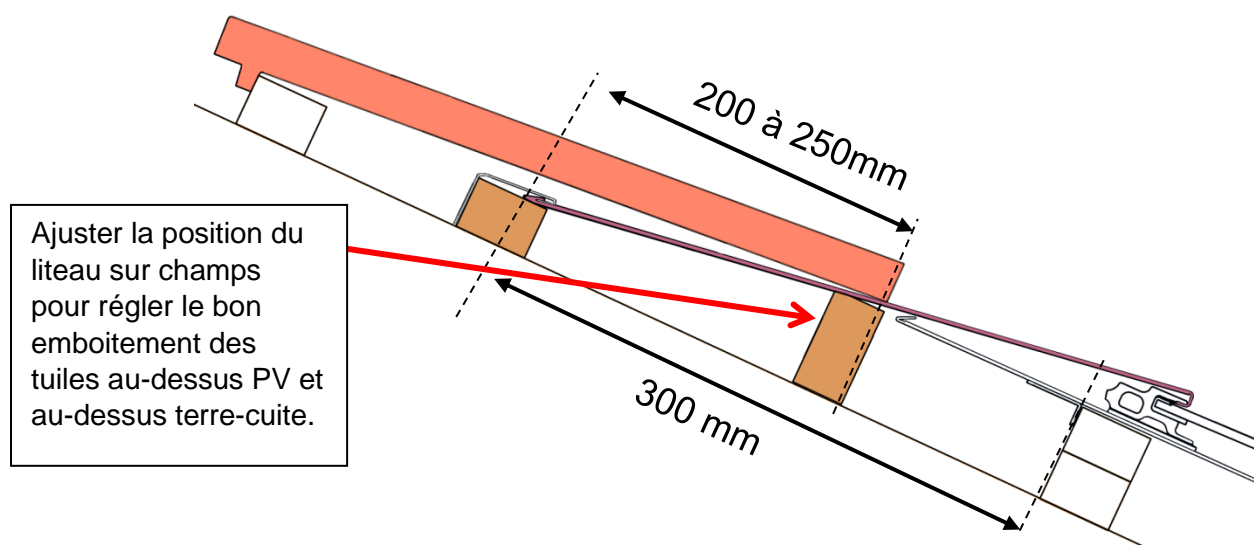

Défaire la bavette pour fixer le liteau puis reprendre l'étape 10.

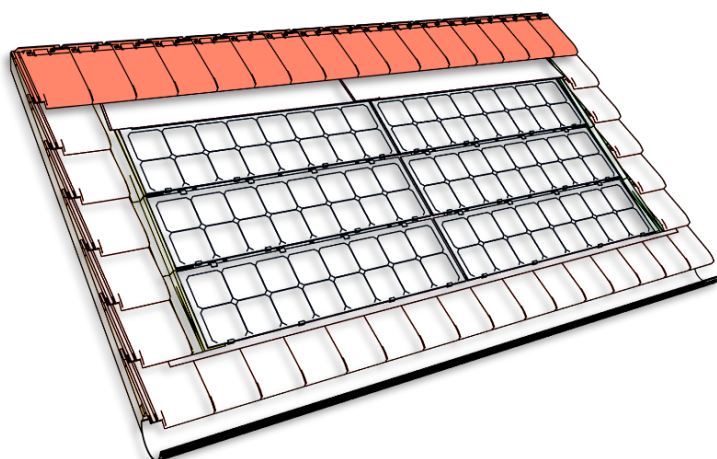

Particularités de mise en œuvre pour certaines tuiles de couverture

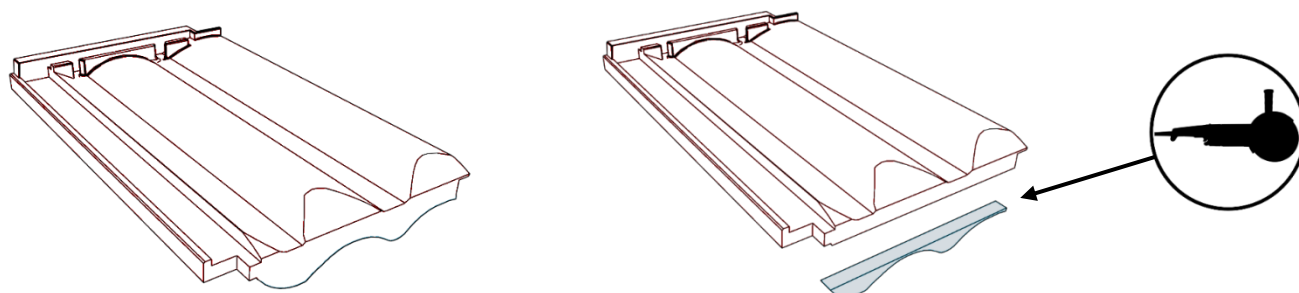

Pour les tuiles galbées, mettre une mousse et entailler au cutter pour suivre le galbe :





## 12. FIXATION DES TUILES AUTOUR DU CHAMP PV

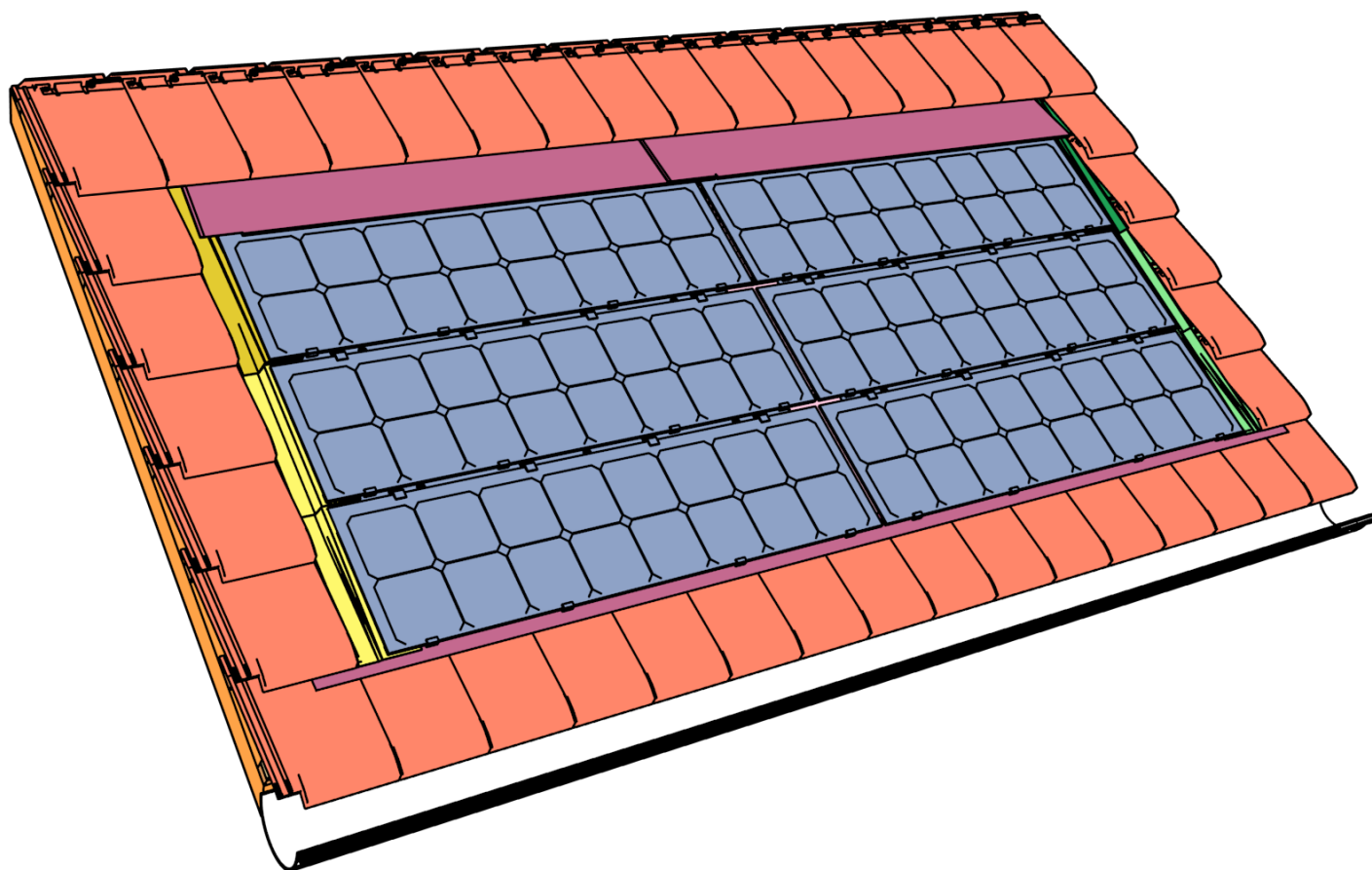
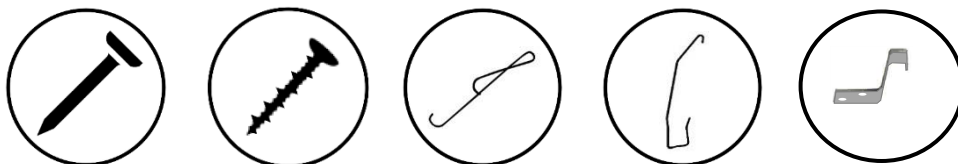

**EDILIANS Site d'ARNAS**  
3, Impasse de Chavanne  
69400 ARNAS  
Hotline : 0810 148 223  
Email : [be.solaire@edilians.com](mailto:be.solaire@edilians.com)



Ce document ne peut être ni reproduit, ni communiqué sans autorisation écrite d'EDILIANS. - Aucune illustration ne peut avoir un caractère contractuel.